

Instruction Manual

Seiko Seiki STPH1301/H1301L1B (P027) Turbomolecular Pump System

(Document number MT-27E-003-C, MT-27E-OC2-A, MT-27E-0D1-A)



**STP-H1301 Series
Turbomolecular Pump
INSTRUCTION MANUAL
(Third Edition - c)**

Read through the Safety Precautions and each section of this Manual carefully before using the STP pump.

Keep this Manual in a place where you can quickly access it at any time.

SAFETY PRECAUTIONS

The Safety Precautions in this Manual constitute guidelines to protect operators, the STP pump and its peripheral equipment. To avoid personal injury and prevent product and/or peripheral equipment damage, observe the Safety Precautions as well as the general safety rules (your country's laws, regulations, safety standards and so on).

SYMBOLS

The following symbols are used in this manual:



Death or Serious Personal Injury

Failure to follow the guidelines marked with this symbol may result in death or serious personal injury.





Minor Personal Injury, Product and/or Peripheral equipment Damage

Failure to follow the guidelines marked with this symbol may result in minor personal injury, product and/or peripheral equipment damage.



Items you must follow during operation and maintenance.

B O C E T cannot perfectly anticipate circumstances of all of hazards or problems. The scope of anticipation is limited to the precautions

included in the  and  specified in this manual.



- ◇ The STP pump is provided with a high-speed rotor. Secure the STP pump according to the specified method. Failure to do so may lead to serious personal injury, product and/or peripheral equipment damage if any abnormality/error occurs in the rotor.
- ◇ The STP pump operates at high temperatures while the baking heater or the Temperature Management System (TMS) unit are in operation. NEVER touch the STP pump and its peripheral equipment while the baking heater or TMS unit in operation.
Operators can burn hands.
- ◇ Always exhaust residual gases thoroughly from the STP pump when removing the STP pump from the vacuum equipment. Residual gases in the STP pump may cause an accident which, for certain gases, may involve serious injury or death.
Confirm the characteristics of the gas to be used, referring to the Material Safety Data Sheet (MSDS) you obtain from the gas supplier.
Wear personal protective equipment if necessary.
- ◇ Exhaust residual gas thoroughly when disposing of the STP pump. If the STP pump is used for any toxic or reactive gas, always clean the STP pump and dispose of it as industrial waste in accordance with guidelines given by the national and/or local government.
Residual gas in the STP pump may cause an accident which, for certain gases, may involve serious injury or death.



- ◇ NEVER use any gas that is not specified as usable in this Manual. The use of such gas may corrode the STP pump and damage it.
- ◇ Always check the STP pump has stopped, then turn OFF the primary power (Switch the breaker "OFF") before proceeding to any of the following operations.
Failure to do so may cause the STP pump to rotate accidentally, which may injure operators seriously or result in electric shock.
 - Connect or disconnect cables;
 - Perform maintenance and inspections such as inspections of deposit and/or the air cooling fan; or
 - Perform investigations into probable causes and action/measures taken in the event of occurrence of a problem.
- ◇ The STP pump is a heavy product. Always use a crane or the like when lifting it. When lifting the STP pump by hands for unavoidable reasons, it must always be lifted by two or more people. Failure to do so may damage your hipbone or cause injuries due to occurrence of an accident such as fall.
- ◇ Install the STP control unit not only by fitting it with the front panel fitting screws but also by supporting it from the bottom side. Fitting the STP control unit with the screws only cannot sustain its weight, and therefore resulting in product damage.
- ◇ Always use the STP pump and STP control unit with the same model name and serial number, which are specified on their own name plate. Failure to do so may result in product damage.
If you plan to use the units having the same model name but different serial numbers or to change the length of the STP connection cable, the tuning is required. If you plan to use the units having different model names, they may not be used even when the tuning is performed. In the latter case, contact Service office.



- ◇ Use the STP connection cable and the motor connection cable that have a label affixed

STP-H1301 Series

- ◇ The use of different cables may result in product damage.
- ◇ Connect the cables securely. NEVER bend nor place heavy objects on the cable. Doing so may result in electric shock or product damage.
- ◇ Always use the power voltage specified on the name plate for the primary power voltage of the STP control unit. Wire the power cable securely. Incorrect wiring may result in electric shock or product damage.
- ◇ NEVER remove the splinter shield from the STP pump. Doing so may result in product damage.
- ◇ DO NOT put foreign objects into the STP pump. Doing so may result in product damage.
- ◇ NEVER turn OFF the primary power (DO NOT switch the breaker "OFF") while the STP pump is rotating. Doing so may result in product damage.
- ◇ Perform investigations into probable causes and remove them before restarting the STP pump in the event of occurrence of a problem. The use of the abnormal STP pump may result in product damage.
- ◇ DO NOT move the STP pump and the STP control unit while the STP pump is in operation. Doing so may result in product damage.

INTRODUCTION

Thank you very much for purchasing BOC Edwards turbomolecular pump. The turbomolecular pump is designed to be installed in the vacuum equipment to exhaust gases from it.

This manual covers all items necessary to ensure safe installation, operation and maintenance of the following series of the STP-H1301 turbomolecular pump:

Model Name	Specification
• STP-H1301C1	High-throughput type, chemical specific *1
• STP-H1301L1	High-throughput type, enhanced chemical specific*2
• STP-H1301CV1	High-throughput type, chemical specific *1, TMS unit*3 attached
• STP-H1301WV1	High-throughput type, enhanced chemical specific*2, TMS unit attached

For the specifications of other models of the STP-H1301 pump series, contact B O C E T.



- ◇ For STP-H1301C, STP-H1301L, STP-H1301WA, and STP-H1301WV, some instructions differ from those for the models listed above. Refer to the Instruction Manual relevant to each model used.

In this manual, the above STP pump series is collectively referred to as the “STP pump.”

*1 : Chemical specific: STP pump with anti-corrosive treatment
(responding to chlorine, fluorine or other system gases)

*2 : Enhanced chemical specific: STP pump for which anti-corrosive treatment is improved for the inside of the pump of the chemical specific type

*3 : TMS unit: Temperature Management System unit

PRECAUTIONS

- 1) No part of this manual may be reproduced in any form by any means without prior written permission from BOCET.
- 2) BOCET pursues a policy of continuing improvement in design and performance of this product. The right is, therefore, reserved to vary specifications and design without notice. Understand that the product you purchased and its contents including specifications described in this manual may differ.

REQUEST

If you find inaccuracies or errors in this manual, advise distributor or the nearest Service office.

LIMITED WARRANTY

This WARRANTY applies to the customer to whom BOCET has delivered this product.

1. WARRANTY PERIOD:

BOCET warrants this product against defects for a period of two (2) years from the date of delivery or during the period specified in the agreement made by and between the customer and BOCET.

2. ITEM WARRANTED:

- 1) This warranty applies only to the product delivered from BOCET to the customer.
- 2) If any defect is found during this period, BOCET will, at its option, repair or recondition the product free of charge. The costs for repair or replacement of the product after the warranty period has passed will be at your own charge.

3. DISCLAIMER:

BOCET makes no warranty with respect to any damage occurred due to any of the following during the warranty period:

- 1) Handling, operation or maintenance other than that specified herein;
- 2) Failure to follow any of the warnings or cautions enumerated under

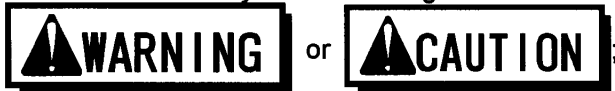

- 3) Installation, operation or maintenance using parts which are not specified by BOCET;
- 4) Maintenance personnel other than those authorized by BOCET or Service office have disassembled, reconditioned, or tampered the product;
- 5) Defect resulting from the not-specified use of the product;
- 6) When the product is used under special conditions without obtaining the written consent of BOCET (Particular gases, strong magnetic field and the radiation are added to the product.);
- 7) Defect resulting from deposit;
- 8) Water cooling system defect resulting from water quality used;
- 9) Defect resulting from the installation of the product (Exclude the installation by authorized personnel.);
- 10) Deterioration in the external because of use (Discoloration, scratches and so forth);
- 11) Product damage occurred during transport or other factors not attributable to BOCET;
- 12) Product breakage or damage due to natural disasters, fire or other external factors;
- 13) Deterioration in the basic performance due to the use of the product beyond limits of the use;
- 14) Any direct, incidental or consequential damage resulting from the use of the product;
- 15) When continuously operated without overhaul after the WARNING indication ("WARNING" message) on the LCD display;
- 16) Overhaul and replacement of maintenance parts;

4. SPARE PARTS:
- Fuse and air cooling fan for control unit
 - Touch down bearing
 - Heater

TABLE OF CONTENTS

SAFETY PRECAUTION

INTRODUCTION

LIMITED WARRANTY

1	Precautions for Safe Operation of the STP Pump.....	1-1
1.1	Usable Gases.....	1-1
1.2	Maintenance and Inspection Precautions	1-1
1.3	Labels	1-2
2	Unpacking	2-1
2.1	Unpacking the STP Pump.....	2-1
2.2	Unpacking the STP Control Unit.....	2-2
3	Installation of the STP Pump.....	3-1
3.1	Name and Function of Each Part	3-1
3.2	Precautions Before Installation.....	3-3
3.2.1	Operating Environment.....	3-3
3.2.2	Installation Area.....	3-4
3.2.3	Bench.....	3-4
3.3	How to Install the STP Pump.....	3-5
3.3.1	Cleaning the Seal	3-6
3.3.2	STP Pump Installation Positions	3-7
3.3.3	How to Secure the STP Pump	3-8
3.3.4	Vacuum Piping	3-12
3.3.5	Connecting the Purge Port.....	3-14
3.3.6	Connecting the Ground Cable.....	3-14
3.3.7	Connecting the Emergency Vent. Valve (Optional Accessory)	3-15
4	Installation of the STP Control Unit	4-1
4.1	Name and Function of Each Part	4-1
4.1.1	Front Panel.....	4-1
4.1.2	Rear Panel	4-4
4.1.3	Top Panel.....	4-6
4.1.4	Side Panel (Left).....	4-7
4.2	Precautions Before Installation.....	4-8
4.2.1	Operating Environment.....	4-8
4.2.2	Installation Area.....	4-9
4.3	Attaching the STP Control Unit to a Rack.....	4-10
4.4	Cable Connection.....	4-11
4.4.1	Name and Dimensions of Each Cable.....	4-11
4.4.2	How to Connect the Cables.....	4-13
5	How to Start/Stop the STP Pump	5-1
5.1	Before Starting	5-1
5.2	Starting/Stopping Time.....	5-1
5.3	Start Procedures	5-2
5.4	Stop Procedures	5-2
5.5	Manual Operation.....	5-3
5.5.1	Powering ON	5-3
5.5.2	Starting the STP Pump.....	5-3
5.5.3	Stopping the STP Pump	5-4
5.5.4	Starting the STP Pump after Stopping	5-4
5.5.5	Powering OFF	5-4
5.5.6	Starting the STP Pump after a Safety Function Operates	5-4
5.6	Remote Operation.....	5-5

5.6.1	Powering ON	5-5
5.6.2	Starting/Stopping the STP Pump	5-5
5.6.3	Starting the STP Pump after Stopping	5-5
5.6.4	Powering OFF	5-6
5.6.5	Starting the STP Pump after a Safety Function Operates	5-6
6	Safety Functions When an Abnormality/Error Occurs	6-1
6.1	Safety Functions	6-2
6.1.1	Power Failure	6-2
6.1.2	Abnormal State of Magnetic Bearing	6-5
6.1.3	Excessive Vibration	6-5
6.1.4	Motor Driver Overload	6-5
6.1.5	Overheating Inside the STP Pump	6-5
6.1.6	Overheating Inside the STP Control Unit	6-5
6.1.7	Overspeed	6-5
6.1.8	TMS Breaker OFF (When TMS Unit is Used)	6-6
6.1.9	TMS Abnormal (When TMS Unit is Used)	6-6
6.2	Restarting after any Safety Function Operates	6-7
6.2.1	In Case of a Power Failure	6-7
6.2.2	In Other Cases	6-7
6.3	Operation of the Emergency Vent. Valve (Optional Accessory)	6-8
7	Gas Suction, Cooling and Baking the STP Pump	7-1
7.1	Gas Suction	7-1
7.1.1	How to Introduce a Purge Gas	7-1
7.2	Cooling the STP Pump	7-2
7.2.1	Water Cooling Method	7-2
7.3	Baking the STP Pump	7-3
7.3.1	Attaching a Baking Heater	7-3
8	Remote Input/Output Signal Connector	8-1
8.1	Input Signal Pins	8-2
8.2	Output Signal Pins	8-4
9	Tuning	9-1
9.1	Tuning Method	9-1
10	Operation Principle of the STP Pump	10-1
11	Maintenance and Inspection	11-1
11.1	Inspecting the Air Cooling Fan	11-1
11.2	Inspecting for Deposit	11-2
11.3	Overhaul	11-3
11.4	Transporting for Repair or Overhaul	11-4
12	Storage	12-1
12.1	The STP Pump	12-1
12.2	The STP Control Unit	12-1
13	Disposal	13-1
13.1	The STP Pump	13-1
13.2	The STP Control Unit	13-1
14	Troubleshooting	14-1
14.1	Troubleshooting Immediately after an Abnormality/Error Occurs	14-1
14.2	When Error Message is Displayed on LCD	14-2
14.2.1	Error Messages	14-2
14.3	Abnormalities When Powering ON	14-6
14.4	Abnormalities When Performing the STP Pump Start Operation	14-6
14.5	Other Abnormalities	14-7

15 Specifications and Accessories.....	15-1
15.1 Specifications for the STP Pump.....	15-1
15.2 Specifications for the STP Control Unit.....	15-2
15.3 Accessories.....	15-4

UNIT CONVERSION TABLE

TABLES

Table 3.1	Tightening torque of bolt.....	3-8
Table 3.2	Maximum Torque predicted and Recommended securing bolt for inlet port flange.....	3-9
Table 3.3	Number of Claw Clamps by Size of Flange.....	3-10
Table 4.1	DIP-B Switch Functions.....	4-6
Table 4.2	Connecting Power Cable.....	4-15
Table 5.1	Starting/Stopping the STP Pump during Remote Operation (I/O CON4).....	5-5
Table 5.2	Reset Operation during Remote Operation (I/O CON4).....	5-6
Table 6.1	States of Lamps and REMOTE Output Signals at a Power Failure.....	6-4
Table 6.2	Operations of the STP Pump after a Power Recovery.....	6-4
Table 6.3	Safety Functions.....	6-9
Table 6.4	Safety Functions (When the TMS Unit is Used).....	6-11
Table 8.1	I/O CON4 Input Signal Pins.....	8-2
Table 8.2	I/O CON4 Output Signal Pins.....	8-4
Table 8.3	Rated Contacts for Relays CR1 to 6.....	8-6
Table 14.1	Error Messages (1/3).....	14-3
Table 14.2	Troubleshooting after Powering ON.....	14-6
Table 14.3	Troubleshooting When Performing the STP Pump Start Operation.....	14-6
Table 14.4	Troubleshooting While the STP Pump Is Rotating.....	14-7
Table 15.1	Specifications for the STP Pump.....	15-1
Table 15.2	Specifications for the STP Control Unit (1/2).....	15-2
Table 15.3	Accessories.....	15-4
Table 15.4	Optional Accessories.....	15-4

FIGURES

Figure 2.1	Example of Lifting the STP Pump	2-1
Figure 3.1	Configuration of the STP Pump	3-2
Figure 3.2	Installation of the STP Pump to the Vacuum Equipment	3-5
Figure 3.3	STP Pump Installation Positions	3-7
Figure 3.4	Example of securing the STP pump (When securing the inlet port with bolts)	3-9
Figure 3.5	Example of securing the STP pump (When securing the inlet port flange with claw clamps)	3-10
Figure 3.6	Example of securing the STP pump (When installing the damper in the inlet port flange).....	3-11
Figure 3.7	Connecting the Purge Port	3-14
Figure 3.8	Connecting the Emergency Vent. Valve	3-15
Figure 4.1	STP Control Unit Front Panel.....	4-3
Figure 4.2	STP Control Unit Rear Panel	4-5
Figure 4.3	STP Control Unit Top Panel.....	4-6
Figure 4.4	STP Control Unit Side Panel (Left).....	4-7
Figure 4.5	Peripheral Space of the STP Control Unit	4-9
Figure 4.6	Example of Securing the STP Control Unit	4-10
Figure 4.7	External Dimensions of Each Cable	4-11
Figure 4.8	External Dimensions of the Power Cable	4-12
Figure 4.9	How to Secure Power Cable.....	4-15
Figure 5.1	STP Pump Operation Procedures	5-7
Figure 7.1	Attaching Positions of the Cooling Unit and Baking Heater.....	7-4
Figure 8.1	I/O CON4 Input Signal Pins	8-3
Figure 8.2	I/O CON4 Output Signal Pins.....	8-5
Figure 9.1	Tuning Procedures.....	9-2
Figure 10.1	Cross Sectional View of the STP Pump	10-2
Figure 15.1	External Appearance of the STP Pump.....	15-5
Figure 15.2	External Appearance of the STP Pump (with Emergency vent. Valve).....	15-6
Figure 15.3	External Appearance of the STP Pump (with TMS Unit).....	15-7
Figure 15.4	External Appearance of the STP Pump (with TMS Unit and Emergency Vent. Valve)	15-8
Figure 15.5	External Appearance of the STP Control Unit	15-9
Figure 15.6	External Appearance of the STP Control Unit (with TMS Control Unit).....	15-10
Figure 15.7	Label Affixing Positions for the STP Pump.....	15-11
Figure 15.8	Label Affixing Positions for the STP Pump (with TMS Unit).....	15-12
Figure 15.9	Label Affixing Positions for the STP Control Unit	15-13
Figure 15.10	Label Affixing Position for the Optional Accessory	15-14

Section 1 Precautions for Safe Operation of the STP Pump

1.1 Usable Gases

The STP-H1301 series models are chemical specific pumps: chlorine or fluorine system gases can be used with these models. When you use gases including alkaline metals, but excluding Li, gases including Ga, Hg, In, or Sn, or HBr, contact B O C E T. Confirm the characteristics of the gas to be used, referring to the Material Safety Data Sheet (MSDS) you obtain from the gas supplier.



- ◇ Introduce a dry N₂ gas (purge gas) to protect the inside of the STP pump when using reactive or corrosive gases (See Section 7.1, "Gas Suction").
- ◇ Cool the STP pump to prevent the STP pump from overheating when sucking gases (See Section 7.2, "Cooling the STP Pump").

1.2 Maintenance and Inspection Precautions

Read through Section 11. "Maintenance and Inspection" before performing any maintenance or inspection of the STP pump and the STP control unit.



- ◇ Always turn OFF the primary power (Switch the breaker "OFF") before performing any maintenance or inspection.
- ◇ NEVER touch any portions other than those designated when performing maintenance or inspection.
Careless touch may cause electric shock and/or a short-circuiting of the internal circuit, resulting in product damage or a problem.

1.3 Labels

The following labels are affixed to the STP pump and STP control unit. Read the contents of the labels before operation. For the positions of the labels, see Figures 15.7 to 15.10.

1) STP Pump Caution Label

This label describes precautions for operating the STP pump. Follow these precautions.

▲注意	▲CAUTION
◇必ず指定の型式のケーブルを使用してください。 ◇最初にアース線を接続してください。	◇Use only designated type of cables. ◇Connect ground cable first.

2) STP Control Unit Caution Label

This label describes precautions for operating the STP control unit. Follow these precautions.

▲注意	▲CAUTION
◇ポンプとコントロールユニットおよび接続ケーブルは同一No.の組合せで使用してください。 ◇必ず指定の型式のケーブルを使用してください。 ◇最初にアース線を接続してください。	◇Use pump, control unit and connection cable with same serial number. ◇Use only designated type of cables. ◇Connect ground cable first.

3) Heavy Product Caution Label



This label is affixed to the product with a weight of 20 kg or more. Follow the precautions of Section 2, "Unpacking" so as not to cause any accident during handling.

▲注意		▲ CAUTION
<u>重量物</u> k g 取扱注意		<u>Heavy product</u> k g Handle with caution.

4) STP Pump Installation Warning Label





This label describes installation of the STP pump.

Install the STP pump according to the precautions of Section 3. "Installation of the STP Pump."

 警告	 WARNING
ポンプは取扱説明書の指示に従い確実に固定してください。	Install pump securely according to instruction manual.

5) Connector Caution Label

- i. This label describes lock of the connector.
- ii. This label instructs operators to prevent the connectors from being disconnected while the STP pump is in operation.

 注意	 Lock	 CAUTION
◇コネクタは確実にロックしてください。 ◇ブレーカONの時はコネクタを外さないでください。	 NO	◇Lock connector securely. ◇Do not remove connector while breaker is ON.

6) STP Control Unit Safety Instruction Label

This label describes instructions before operating the STP control unit.

安全上の指示事項	SAFETY INSTRUCTIONS
使用前に取扱説明書をお読みください。	Read instruction manual before operation.

7) High Voltage Device Caution Label

The STP control unit is equipped with a high voltage device. This label warns operators to pay attention to the high voltage device.

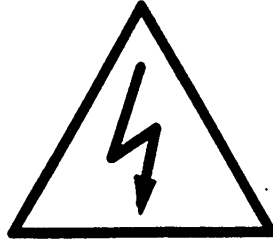

8) Rotational Direction Instruction Label

This label describes the rotational direction of the STP pump. The STP pump rotates in this direction.

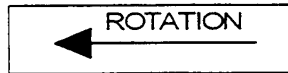

9) Voltage Rating Label

This label describes the rated voltage of the STP control unit. Use voltage specified in this label.

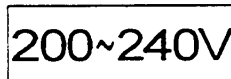

10) Emergency Vent. Valve Caution Label (for Emergency vent. Valve)

This label describes the emergency vent. valve installation position. Connect the emergency vent. valve before use.

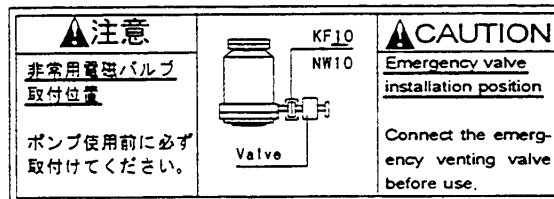

11) Hot Surface Warning Label

This label instructs operators so as not to touch the hot surface of the STP pump.

The use of the baking heater (optional accessory) or the TMS unit may lead to a considerable rise in temperatures outside the STP pump.

This label warns operators so as not to burn hands.

(only when using the baking heater or the TMS unit)

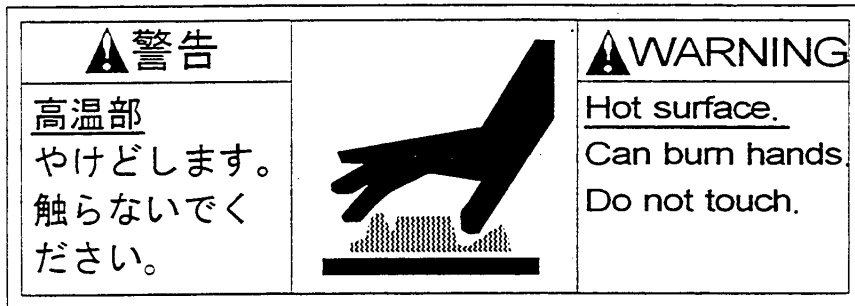

Section 2 Unpacking

2.1 Unpacking the STP Pump

Check the following before unpacking the STP pump.

- 1) Check the package for bruises, breakage, wetness, and other.
If there is any abnormality/error or it is judged necessary to return the product, contact BOCET or the selling agency.

- 2) Check the contents of the package.
See Section 15.3. "Accessories."



- ◇ The net weight of the STP pump is approx. 36 kg. Use a crane or other appropriate means to lift the STP pump.
Lift the STP pump with an eyebolt or a similar tool that uses the fitting hole attached to the inlet port flange.
Lift it with the aid of a suspension tool under the base when installing the STP pump without fitting hole.
- ◇ Observe national laws/regulations, safety standards and so on when lifting the STP pump.
- ◇ Use a crane or other appropriate means sufficient enough to withstand the load when lifting the STP pump.
- ◇ Always lift the STP pump in stable places free of excessive shock or vibration to prevent it from shaking or dropping.
- ◇ Have at least two people lift the STP pump when doing so by hand.



- ◇ Be careful not to scratch the flange of the STP pump.
Before installing the STP pump, check whether or not there are scratches on the surface.
- ◇ It is recommended to keep the packaging materials, such as the corrugated fiberboard container and cushioning material for possible reuse.

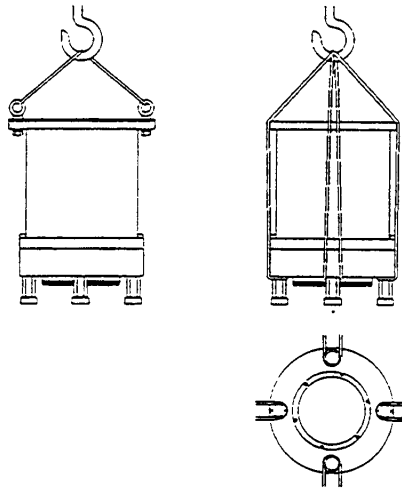

Figure 2.1 Example of Lifting the STP Pump

2.2 Unpacking the STP Control Unit

Check the following before unpacking the STP control unit.

- 1) Check the package for bruises, breakage, wetness, and others.
If there is any abnormality/error or it is judged necessary to return the product, contact BOCET or the selling agency.

- 2) Check the contents of the package.
See Section 15.3. "Accessories."



- ◇ It is recommended to keep the packaging materials, such as the corrugated fiberboard container and cushioning material for possible reuse.

Section 3 Installation of the STP Pump

3.1 Name and Function of Each Part

(See Figure 3.1.)

- ① Inlet Port Flange (VG*¹, ISO, and other)
 - Connected to the vacuum equipment (at the high vacuum side).



- ◇ A splinter shield is attached to the inlet port flange to prevent foreign materials from falling into the STP pump.
NEVER remove it.

- ② Outlet Port Flange (KF*¹ 40)
 - Connected to the inlet port side of the auxiliary pump.

- ③ STP Connector (41 pins)
 - Connected to the STP connection cable.

- ④ Motor Connector (5 pins)
 - Connected to the motor connection cable.

- ⑤ Purge Port (KF*¹ 10)
 - Introduces a purge gas.
In order to protect the inside of the STP pump when sucking reactive or corrosive gases.
The STP pump is delivered with a blank flange attached to this port.

- ⑥ Cooling Water Port (PT*¹ (RC) 1/4 Female Screw)
 - Connected to the STP pump cooling water pipe.
This port is used when water cooling the STP pump.

- ⑦ Ground Terminal
 - Used for grounding.
Connect the ground cable between this terminal and the ground terminal of the STP control unit.
The ground terminal is marked with ⚡ label.

- ⑧ Emergency Vent. Valve (optional accessory)
 - Protects the STP pump.
It functions immediately after any abnormality/error occurs inside the STP pump.

- ⑨ Temperature Sensor Connector (optional accessory)
 - A temperature sensor is attached.
For use with the Temperature Management System (TMS) unit only.

*¹: JIS

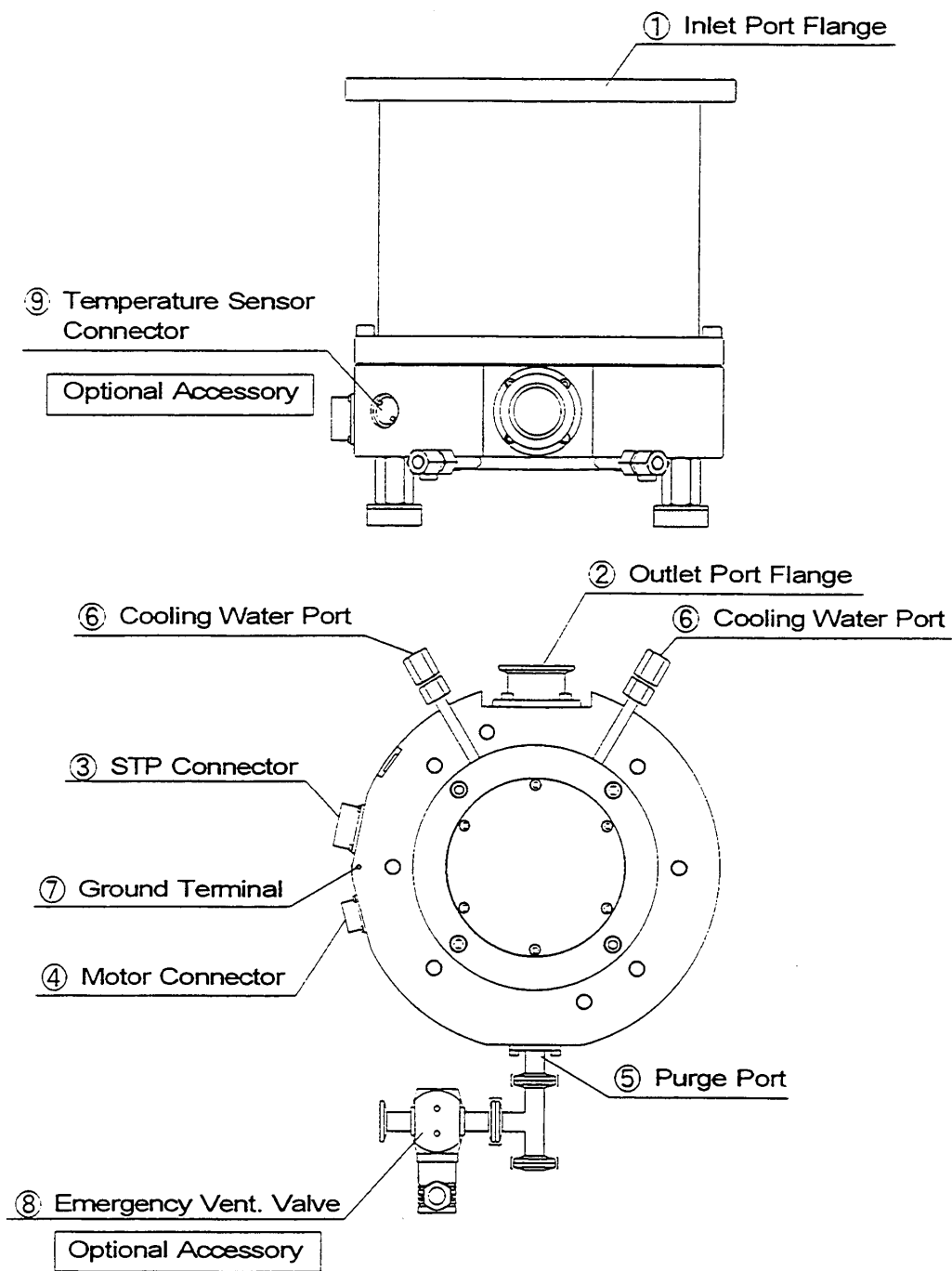

Figure 3.1 Configuration of the STP Pump

3.2 Precautions Before Installation

3.2.1 Operating Environment



- ◇ The STP-H1301 series models are chemical specific models: chlorine or fluorine system gases can be used with these models. When you use gases including alkaline metals, but excluding Li, gases including Ga, Hg, In, or Sn, or HBr, contact BOCET (See Section 1.1, "Usable Gases").

Install the STP pump in a place meeting the following requirements:

Ambient Temperature	0 to 40 °C
Ambient Relative Humidity	30 to 95 % (no dew condensing)
Environment	<ul style="list-style-type: none"> • A place free of externally-applied mechanical shock. • A place free of a heat source (Keep clear of the heat source or attach a thermal shield plate). • A place free of a strong magnetic field (Range: up to <u>150 gauss (15 mT) in the axial direction</u>, and up to <u>30 gauss (3 mT) in the radial direction</u> with respect to the rotational axis of the STP pump). • A place free of a strong electric field. • A place free of exposure to radiation. • No discharge of high voltage (more than 500 V) (If more than 500 V is discharged, contact BOCET).
STP Pump Installation Equipment Conditions	<ul style="list-style-type: none"> • Install the STP pump securely so that foreign materials will easily fall into the STP pump (Ex.: Si wafers or samples are positioned above the STP pump) (To prevent foreign materials from falling into the STP pump, design a shield plate with large conductance).

3.2.2 Installation Area

Leave enough space for the following in addition to that for the STP pump:

- Space for maintenance and inspection
- Space for connecting cables



- ◇ The minimum bending radius of the STP connection cable is 150 mm (see Figures 15.1 to 15.4, "External Appearance of the STP Pump" [bending dimensions of the STP connection cable]).
DO NOT excessively bend the cables and beware of any obstacles when installing the STP pump.
Also, leave enough space to install other cables without bending them excessively.

3.2.3 Bench

A bench must be prepared by the customer to secure the STP pump. The shape and size of the bench differ depending upon the type of STP pump. Follow the precautions of the WARNING, CAUTION, or NOTICE (See Section 3.3.3, "How to Secure the STP Pump").



- ◇ The STP pump is provided with a high-speed rotor. Any internal abnormality/error may result in a jump in rotational torque leading to personal injury or peripheral equipment damage.
Design and secure the bench for the STP pump so that it can withstand the maximum torque generated due to the occurrence of an abnormality/error.
Refer to Section 3.3.3 "How to Secure the STP Pump" for abnormal torque.



- ◇ Secure the customer-prepared bench and the vacuum equipment on the floor or peripheral equipment and other equipment in accordance with the customer application. NEVER move them while the STP pump is in operation.
- ◇ Use fitting bolts with strength equal to or higher than SUS 304^{*1}.
(Tensile strength class^{*1}: 50 or more as a target)



- ◇ The screw hole for leg for securing the STP pump is M12^{*1} and the depth is 24mm (8 positions).
- ◇ For the external appearance of the STP pump, see Figures 15.1 to 15.4, "External Appearance of the STP Pump."



- ◇ The screw hole for leg for securing the STP pump is M12¹, and the depth is 24 mm (8 positions).
For the external appearance of the STP pump, see Figures 15.1 to 15.4, "External Appearance of the STP Pump."

3.3 How to Install the STP Pump

Install the STP pump to the vacuum equipment as shown in Figure 3.2.
For the installation of the TMS unit, refer to the Instruction Manual of the TMS unit.

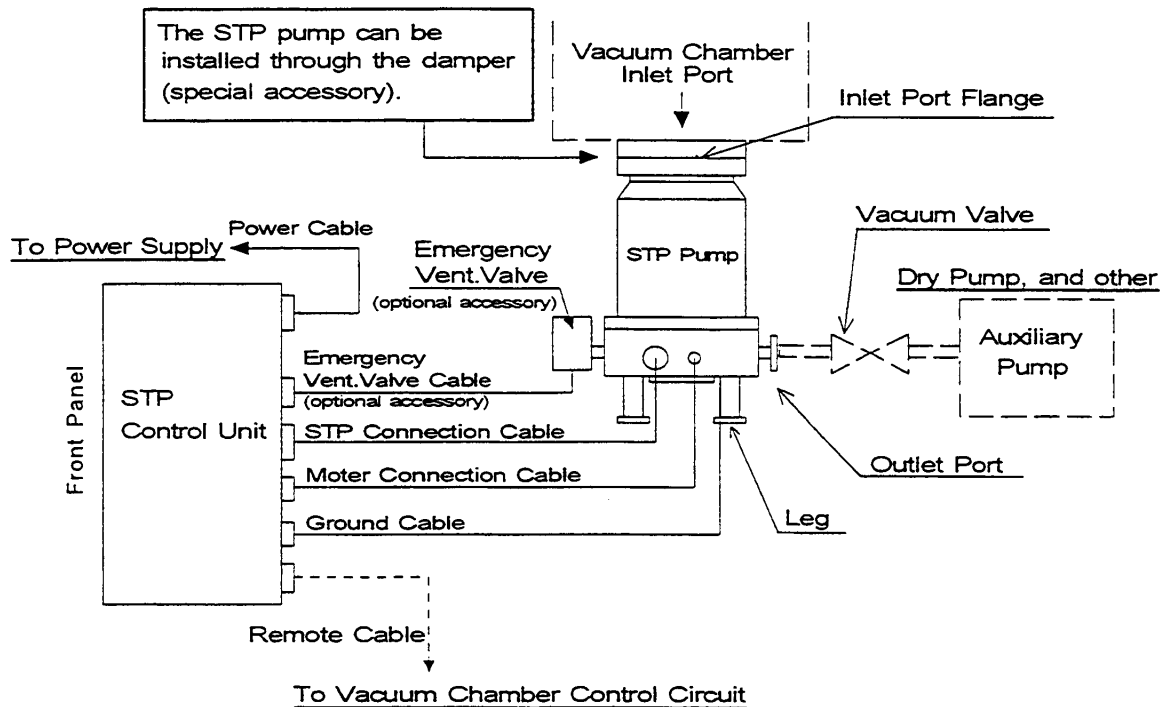

Figure 3.2 Installation of the STP Pump to the Vacuum Equipment

CAUTION

- ◇ Chlorine or fluorine system gases can be used in the STP-H1301 series models. When you use gases including alkaline metals, but excluding Li, gases including Ga, Hg, In, or Sn, or HBr, contact BOCET (See Section 1.1, "Usable Gases").
- ◇ When you use the STP pump in a place subjected to exposure to radiation, contact BOCET.
- ◇ DO NOT open the STP pump through the flange to atmospheric air while the STP pump is running.
If atmospheric air flows into the STP pump, it may not function normally.
- ◇ Depending upon the type of the auxiliary pump used, atmospheric air may reverse flow into the STP pump when the auxiliary pump stops. Attach a vacuum valve to the middle of the piping between the STP pump outlet port flange and the auxiliary pump, and close the vacuum valve when the auxiliary pump stops.

NOTICE

- ◇ The STP pump cannot be used with the outlet port open to atmospheric air.
Always use the auxiliary pump (dry pump or similar one).
- ◇ Use an auxiliary pump with a pumping speed of 240 lit./min. or more.
- ◇ Depending upon the type of the auxiliary pump used, oil vapor may contaminate the inside of the STP pump. Some oil viscosity could cause a malfunction when there is a strong reverse flow of oil.
Take the following measures to ensure the correct flow of oil:
 - Attach a vacuum valve to the middle of the piping between the STP pump outlet port flange and the auxiliary pump.
 - Attach an absorption trap adjacent to the vacuum valve.

3.3.1 Cleaning the Seal

Inspect the seals of inlet and outlet port flanges for dirt or oil spots before installing the STP pump to the vacuum equipment.

Take the following measures for cleaning the seals:

- Clean off with a pure gas.
- Wipe with proper solvent (such as alcohol).

CAUTION

- ◇ A splinter shield is attached to the inlet port flange to prevent foreign materials from falling into the STP pump.
Always leave the splinter shield attached during operation.

NOTICE

- ◇ The splinter shield cannot perfectly prevent foreign materials from falling into the STP pump.
DO NOT install the STP pump in such a manner that foreign materials can easily fall into it (for example, Si wafers or samples are positioned above the STP pump). If installing the STP pump in such a manner, always attach a shield plate with sufficient conductance above the STP pump to prevent foreign materials from falling into it. Foreign materials falling into the STP pump through the splinter shield may result in product damage.
- ◇ Be careful not to scratch the flange of the STP pump.
Check whether or not there are scratches on the surface, before installing the STP pump.

3.3.3 How to Secure the STP Pump



- ◇ The STP pump is provided with a high-speed rotor. The worst-case failure may result in a jump in rotational torque leading to personal injury or peripheral equipment damage.
The method of securing the STP pump will depend on the installation requirements. Secure the STP pump to the vacuum equipment as follows:
- ◇ Design and secure the mounting for the STP pump so that it can withstand the maximum rotational torque. Refer to Table 3.2 for torque in pump abnormality.

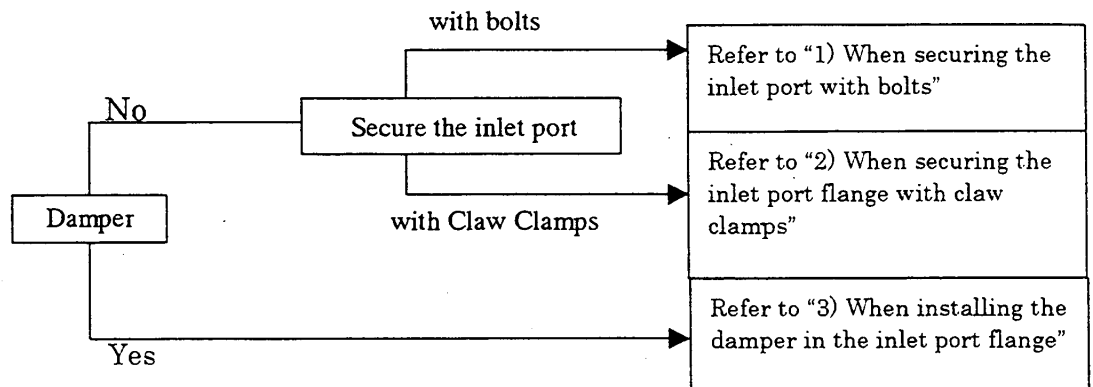

- ◇ In some cases, the damper and the claw clamping securing cannot be used depend on the type of the STP pump.
- ◇ Refer to Table 3.1 for tightening torque of the bolt.

Table 3.1 Tightening torque of bolt

Size of bolt	Tightening torque of bolt (Nm)
M8	12.0
M10	24.1
M12	42.1

- ◇ When making the leg to secure the base, make them shortened more than ones attached to the STP pump.
Use a material that has a tensile strength of 600N/mm² or more.
- ◇ When securing the base, use stainless steel securing bolts with a tensile strength class is 70 or more.



- ◇ When using any securing method other than that specified in this manual, contact BOCET.

1) When securing the inlet port with bolts

Refer to Table 3.2 for torque in pump abnormality and recommended securing bolts. Secure the inlet port flange with all of the boltholes of the size specified in the Inlet Port Flange Standard.

Secure the base with all 8 screw-holes for legs or all 8 attached legs.

Follow "CAUTION" on page 3-8 about legs and bolts for securing the base.

Make sure that the recommended securing bolt may be different depending on the method of securing the base.

Table 3.2 Maximum Torque predicted and Recommended securing bolt for inlet port flange

Model of TMP		STP-H1301			
Type of flange		VG200		ISO200F	
Torque in pump abnormality [Nm]		2.4×10 ⁴		2.4×10 ⁴	
Base(8 positions)securing		No	Yes	No	Yes
Recommended securing bolt for TMP Flange	Type of bolt	Standard	Standard	Standard	Standard
	Type of steel ^{*1}	Stainless steel	Stainless steel	Stainless steel	Stainless steel
	Strength ^{*1}	70 or more	70 or more	70 or more	70 or more

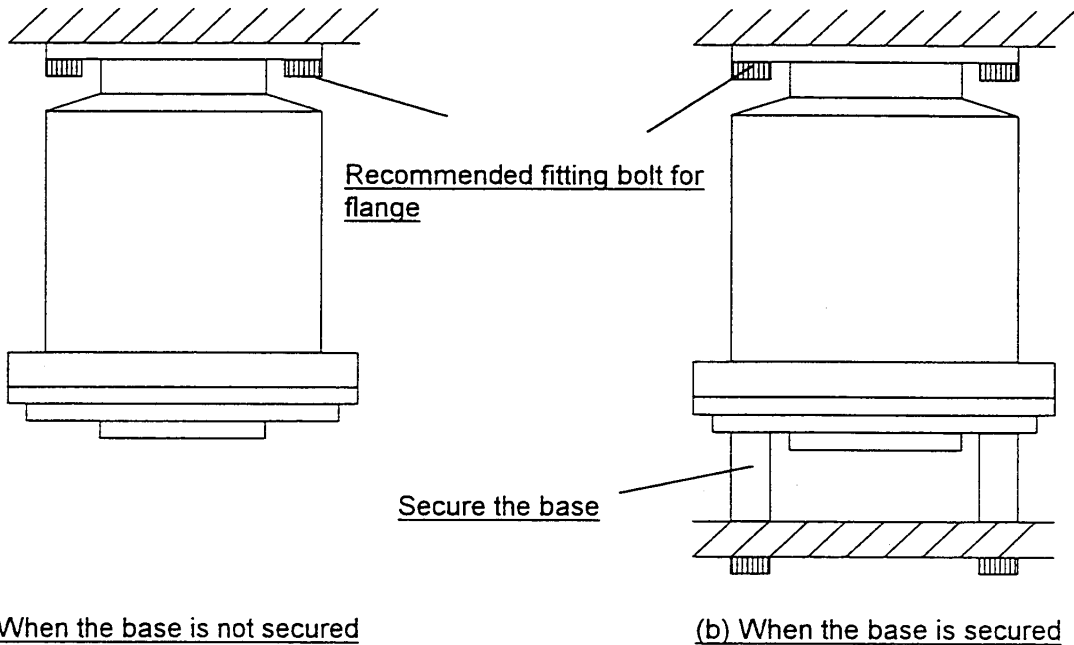

Figure 3.4 Example of securing the STP pump
(When securing the inlet port with bolts)

^{*1} Refer to ISO898-1(JISB1051), ISO3506(JISB1054) and AMS6119(Aerospace Material Specification)

2) When securing the inlet port flange with claw clamps

Refer to Table 3.2 for rotational torque.

When securing the inlet port flange with only the claw clamp, the vacuum equipment cannot withstand the maximum rotational torque generated by the worst-case failure. To make the vacuum equipment withstand abnormal torque, secure the base with all 8 screw-holes for legs or all 8 attached legs.

Follow "CAUTION" on page 3-8 about legs and bolts for securing the base.

For the claw clamp-type, use the required number of claw clamps as specified in Table 3.3. Position the claw clamps evenly on the circumference.

Table 3.3 Number of Claw Clamps by Size of Flange

Size of Flange	Number of Claw Clamps
ISO 160 or less	4 or more
ISO 200 to 250	6 or more
ISO 320 or more	8 or more

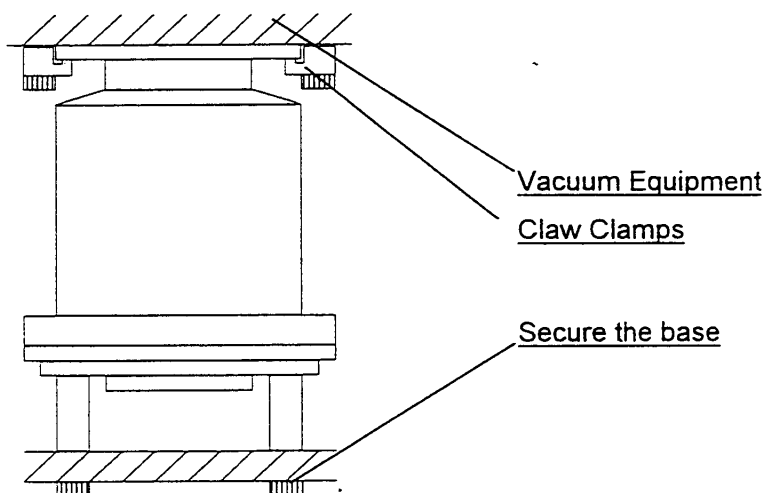

Figure 3.5 Example of securing the STP pump
(When securing the inlet port flange with claw clamps)

3) When installing the damper in the inlet port flange

Refer to Table 3.2 for rotational torque.

In case of using a damper, secure the base with all 8 screw-holes for legs or all 8 attached legs. Follow "CAUTION" on page 3-8 about legs and bolts for securing the base.

When the base cannot be secured because of the equipment design, install the pump with a torque restraint like the one shown in Figure 3.6 (b).



- ◇ Use a damper only at the vertically upright position.
- ◇ DO NOT remove the bolts and nuts attached to reinforce the damper.

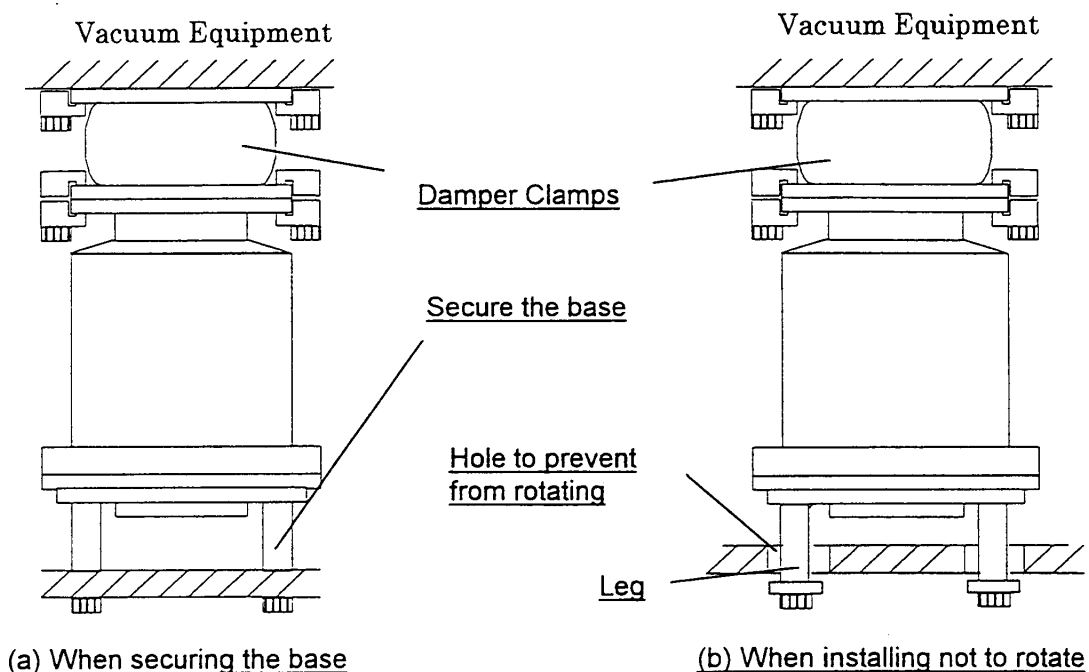

Figure 3.6 Example of securing the STP pump
(When installing the damper in the inlet port flange)

3.3.4 Vacuum Piping

- ◇ DO NOT open the STP pump through the flange to atmospheric air while the STP pump is running.
If atmospheric air flows into the STP pump, it may not function normally.
- ◇ Depending upon the type of the auxiliary pump used, atmospheric air may reverse flow into the STP pump when the auxiliary pump stops.
Attach a vacuum valve to the middle of the piping between the STP pump outlet port flange and the auxiliary pump, and close the vacuum valve when the auxiliary pump stops.

In order to let the STP pump bring its performance into full play, follow the precautions below:

- 1) Be careful not to scratch the flange of the STP pump.
Before installing the STP pump, check whether or not there are scratches on the surface.
- 2) Use steel or aluminum tubes with a low gas loss to connect the vacuum equipment to the STP pump.
- 3) Take measures for minimizing leakage. It is also necessary to degrease the tubes as regularly as possible to keep the gas loss as low as possible.
- 4) It is recommended to use an auxiliary pump of pumping speed 240 L/min or more.
However, the pressure at the inlet and outlet ports varies with the flow rate of gas, capacity of the vacuum equipment, length and material of the piping. Select an auxiliary pump in accordance with the capacity and starting method (simultaneous starting, starting after generating roughing vacuum) suitable for the vacuum equipment you use.
- 5) Connect the STP pump and the auxiliary pump using stainless steel or aluminum alloy tubing, flexible tubing, vacuum rubber or Teflon tubing, and other.
The following measures can be used to avoid the transmission of the vibration of the auxiliary pump to the STP pump and the vacuum equipment.
 - DO NOT place the auxiliary pump on the same floor as the vacuum equipment.
 - Locate the auxiliary pump on a vibration-proof table.
Attain 1/3 or less of the rotational speed of the auxiliary pump, when adjusting the inherent frequency of the auxiliary pump installed on a vibration-proof table.
 - Attach a weight to the piping from the auxiliary pump, or secure the piping to a rigid, heavy object free of vibration.
 - Use a tube of high flexibility.
- 6) Depending upon the type of the auxiliary pump used, oil vapor may contaminate the inside of the STP pump. Some oil viscosity could cause a malfunction when there is a strong reverse flow of oil.
Take the following measures to ensure the correct flow of oil:
 - Attach a vacuum valve to the middle of the piping between the STP pump outlet port flange and the auxiliary pump.
 - Attach an absorption trap adjacent to the vacuum valve.

1) Piping at the Inlet Port Flange

Attach the inlet port to the high vacuum side.

Maximum working pressure (Pressure at the inlet port flange applicable continuously)

- 13.3Pa [0.1Torr] (for water cooling)
- 5.3Pa [0.04Torr] (when TMS unit is used)

2) Piping at the Outlet Port Flange

Attach the outlet port to the inlet port flange of the auxiliary pump (primary side pump).

Allowable backing pressure (Pressure at the outlet port flange applicable continuously)

- 270 Pa [2 Torr] (for water cooling or when TMS unit is used)



- ◇ To attain the ultimate pressure shown in Table 15.1, "Specifications for the STP Pump," set the pressure at the outlet port flange to 1.3 Pa (10^{-2} Torr) or less.

3.3.5 Connecting the Purge Port

When sucking reactive or corrosive gases, introduce a dry N₂ gas or other gas into the STP pump in order to protect the inside of the STP pump.

As shown in Figure 3.5, introduce a dry N₂ gas through the electromagnetic vent valve, needle valve or similar valve (must be prepared by the customer) from the purge port.

For instructions on how to introduce the purge gas, see Section 7.1, "Gas Suction."

NOTICE

- ◇ The proper amount of gas purge is approx. $3.4 \times 10^{-2} \text{ Pa} \cdot \text{m}^3/\text{sec}$. (20 SCCM).
- ◇ The allowable gas pressure ranges from zero [atmospheric pressure] to $4.9 \times 10^4 \text{ Pa}$ [gauge pressure] (zero [atmospheric pressure] to 0.5 kgf/cm^2 [gauge pressure]).
- ◇ When not introducing the purge gas, close the purge port with the blank flange (attached at delivery).

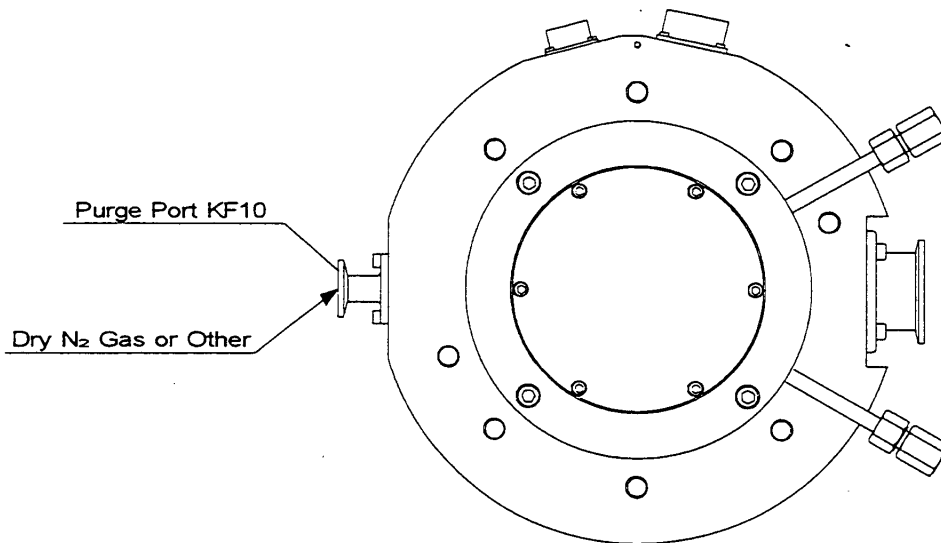

Figure 3.7 Connecting the Purge Port

3.3.6 Connecting the Ground Cable

Connect the ground cable (yellow/green) between the ground terminal of the STP pump and the ground terminal of the STP control unit.

When the resistance between the ground terminals is lower than 0.1Ω , it is not necessary to connect the ground cable after installing the STP pump and the STP control unit.

CAUTION

- ◇ When the resistance between the ground terminals is over 0.1Ω , always connect the ground cable.

3.3.7 Connecting the Emergency Vent. Valve (Optional Accessory)

The emergency vent. valve stops the STP pump by introducing gases if any abnormality/error occurs in the STP pump.

Connect the emergency vent. valve to the purge port as shown in Figure 3.6. Note that the side of the emergency vent. valve without filter is connected to the purge port.

Connect the cable for the emergency vent. valve to the connector, LEAK VALVE CON6, of the STP control unit.

Set dip switch 6 of DIP-B on the top panel of the STP control unit to the "ON" position (see Section 4.1.3, "Top Panel").



- ◇ DO NOT close the port of the emergency vent. valve (filter side) with a blank flange or other type of device.



- ◇ The allowable gas pressure ranges from zero [atmospheric pressure] to 4.9×10^4 Pa [gauge pressure] (zero [atmospheric pressure] to 0.5 kgf/cm^2 [gauge pressure]).
- ◇ Use a dry N₂ gas or atmospheric air.
- ◇ If the STP pump is delivered with the emergency vent. valve attached, dip switch 6 of DIP-B is factory-set to "ON."

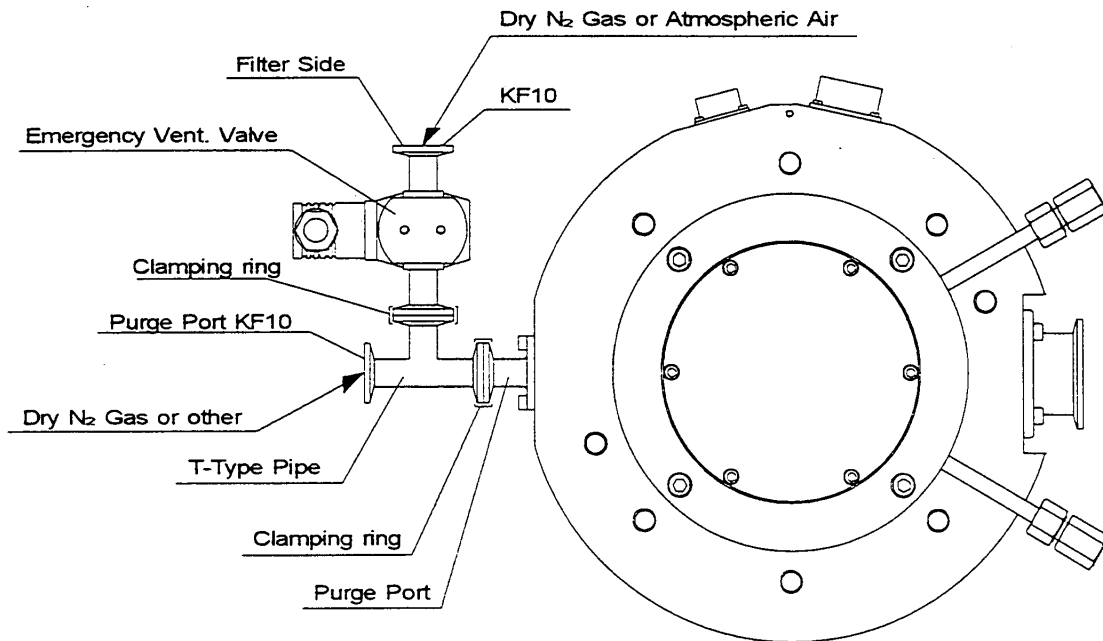

Figure 3.8 Connecting the Emergency Vent. Valve

Section 4 Installation of the STP Control Unit

4.1 Name and Function of Each Part

4.1.1 Front Panel

(See Figure 4.1.)

- ① "START" Switch (momentary push button switch, green)
 - STP pump rotating function (valid in MANUAL operation only).
Press this switch to start and accelerate the STP pump when the LCD displays "LEVITATION" or "BRAKE : ***00rpm" (***00rpm indicates the current rated speed).
The "ACCEL." lamp lights simultaneously.
- ② "STOP" Switch (momentary push button switch, red)
 - STP pump stop operation function (valid in MANUAL operation only).
Press this switch to decelerate and stop the STP pump. The "NORMAL" or "ACCEL." lamp goes out and the "BRAKE" lamp lights simultaneously.
When the number of rotations is less than approx. 2000 rpm while the STP pump is accelerating, the "BRAKE" lamp does not light.
- ③ "RESET" Switch (momentary push button switch, white)
 - Alarm reset function (valid in MANUAL operation only).
When a safety function operates with the "FAILURE" lamp lit, stop the STP pump and remove the cause of the failure. Then, press this switch to restart the STP pump. The "FAILURE" lamp goes out simultaneously.
 - Tuning function (valid in both MANUAL or REMOTE operation).
To perform tuning, press and hold this switch for 3 seconds or more when the STP pump is in the levitation state.
(See [Section 9. "Tuning."](#))



- ◇ The tuning function is not available for STP-H1301C, STP-H1301L, STP-H1301WA, and STP-H1301WV.
- ④ "MANUAL/REMOTE" Chageover Switch (slide switch, gray)
 - Operation mode changeover function.
When this switch is set to the position opposite to "ON," the start and stop operations using switches on the front panel are possible (MANUAL operation). In this mode, the "REMOTE" lamp is off. When this switch is set to "ON," the start and stop operations using remote signals are possible (REMOTE operation). In this mode, the "REMOTE" lamp is on.

- ⑤ "SELECT" Switch (momentary push button switch, white)
 - LCD message display change function (valid in both MANUAL and REMOTE operations).
 - Press this switch to change the message on the LCD
(See Section 5. "How to Start/Stop the STP Pump." Section 6. "Safety Functions When an Abnormality/Error Occurs." and Section 14. "Troubleshooting").

- ⑥ LCD
 - The LCD displays a pump's operation state, speed, or other messages.
 - For the messages displayed, see Section 5. "How to Start/Stop the STP Pump." and Section 9. "Tuning."
 - The LCD displays an error message when an abnormality/error occurs in the STP pump.
 - For the error messages and action to be taken, see Section 6. "Safety Functions When an Abnormality/Error Occurs." and Section 14. "Troubleshooting."

- ⑦ "ACCEL." Lamp (green LED)
 - Lights during acceleration (ACCELERATION state).

- ⑧ "NORMAL" Lamp (green LED)
 - Lights during rated speed operation (NORMAL OPERATION state).

- ⑨ "BRAKE" Lamp (yellow LED)
 - Lights during deceleration (BRAKE state).

- ⑩ "POWER" Lamp (green LED)
 - Lights while the power is ON.
 - Goes out while the backup power is being supplied.

⑪ "FAILURE" Lamp (red LED)

- Lights when any of the following abnormalities/errors occurs.
- The LCD displays an error message simultaneously.
 - a) When the inside of the STP control unit overheats (70 °C or more inside the circuit);
 - b) When the inside of the STP pump overheats (110 °C or more inside the motor or electromagnet);
 - c) When the motor driver overloads;
 - d) When a power failure occurs;
 - e) When the STP connection cable is not connected;
 - f) When vibration impact is continuously applied to the rotor causing it to come into contact with the touch down bearing.

For details of abnormalities/errors, see Section 6. "Safety Functions When an Abnormality/error Occurs." and Section 14. "Troubleshooting."

⑫ "REMOTE" Lamp (green LED)

- Lights while the operation mode is remote.

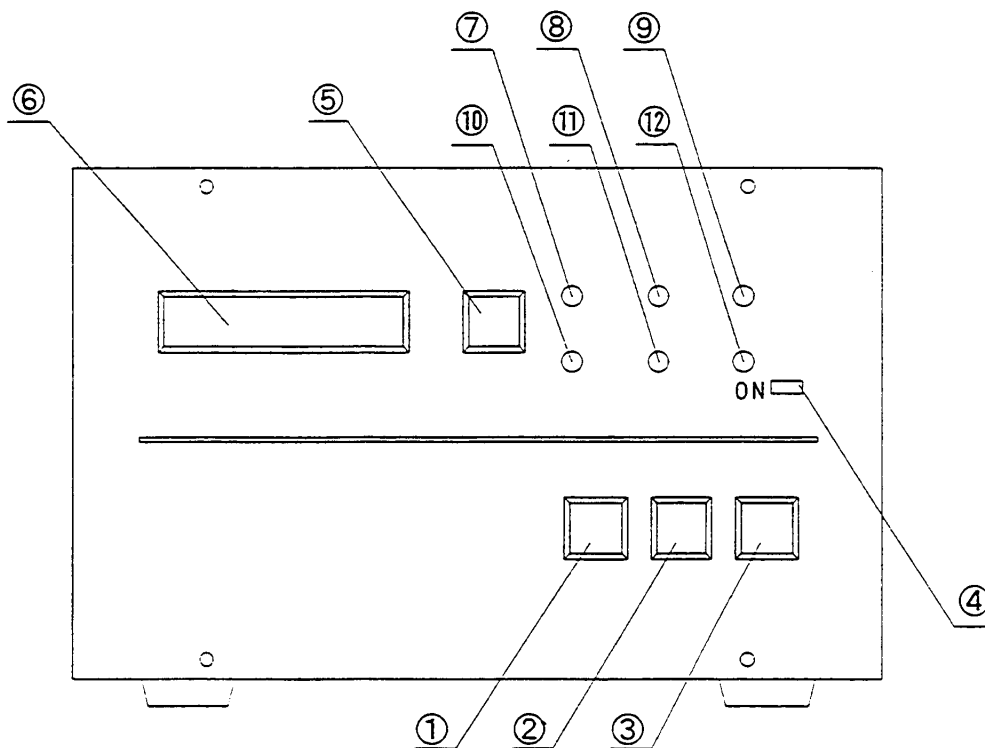

Figure 4.1 STP Control Unit Front Panel

4.1.2 Rear Panel

(See Figure 4.2.)

- ⑬ AC POWER Connector (CON1)
 - For primary power input.
- ⑭ MAIN POWER Breaker
 - Switches ON/OFF the primary power.
 - A metal fitting is attached to secure the breaker at the OFF position.
- ⑮ P. CONNECTOR (CON2)
 - For connection of the STP connection cable.
- ⑯ MOTOR Connector (CON3)
 - For connection of the motor connection cable.
- ⑰ I/O Connector (CON4)
 - For input/output of the remote signals.

For details of the I/O Connector (CON4), see Section 8. "Remote Input/Output Signal Connector."

- ⑱ I/O connector (CON5)
 - For connection of the TMS unit.
Use this connector when using the TMS unit.



- ◇ **This connector is dedicated to the TMS unit. DO NOT connect anything when not using the TMS unit.**
- ⑲ LEAK VALVE Connector (CON6)
 - For connection of the emergency vent. valve cable.
Use this connector when using the emergency vent. valve (optional accessory).
This connector functions when dip switch 6 of DIP-B on the top panel is set to ON and it does not function when OFF.
- ⑳ Ground Terminal
 - For connection of the ground cable between the STP pump and the STP control unit.

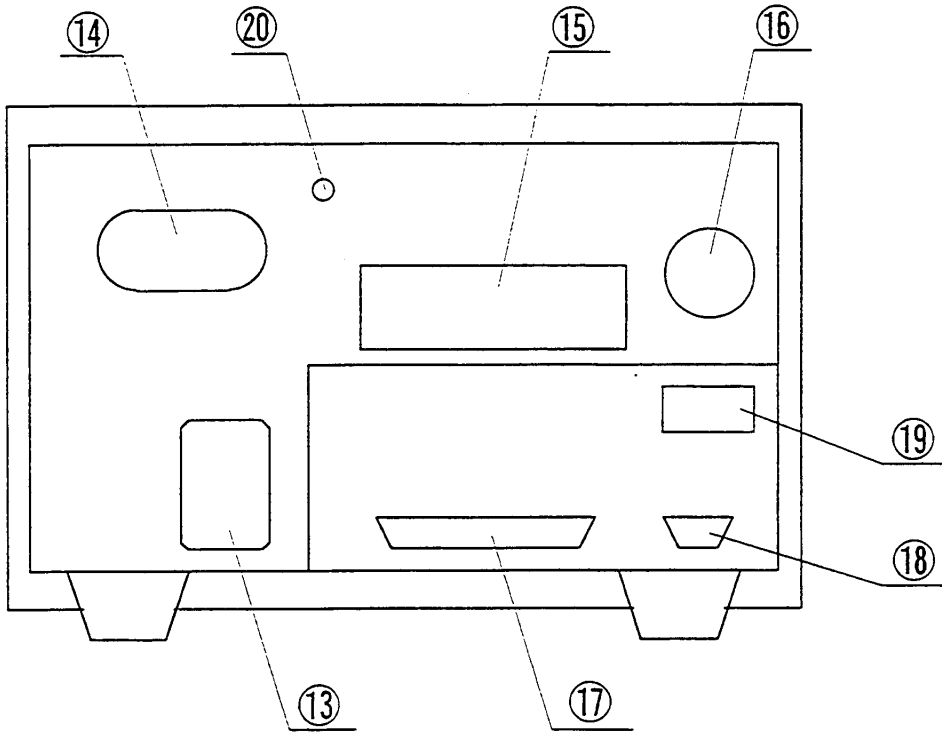

Figure 4.2 STP Control Unit Rear Panel

4.1.3 Top Panel

(See Figure 4.3.)

① VR1 Volume

- For an extended function.
This volume is not used.

② DIP-B Dip Switches

- For extended functions.
Figure 4.3 and Table 4.1 show the functions and factory settings of the dip switches.



- ◇ DIP-B cannot be used for STP-H1301C, STP-H1301L, STP-H1301WA, and STP-H1301WV.

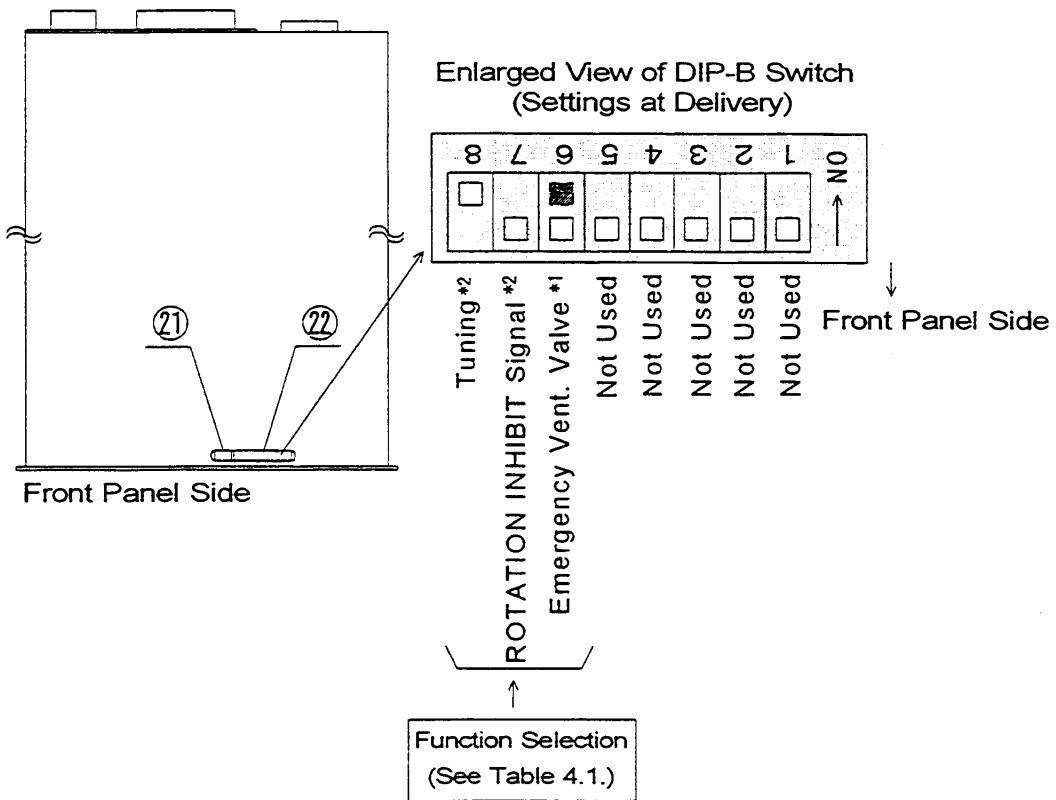

*1: The factory-setting of DIP-B switch 6 depends on whether or not the emergency vent. valve is attached at delivery.

*2: For the ROTATION INHIBIT signal, see Section 8.1. "Input Signal Pins." For the tuning, see Section 9. "Tuning."

Figure 4.3 STP Control Unit Top Panel

Table 4.1 DIP-B Switch Functions

Switch No.	Function	When set to ON	When set to OFF (opposite side of ON)
6	Emergency vent. valve	Valid	Invalid
7	ROTATION INHIBIT signal	Invalid	Valid
8	Tuning	Valid	Invalid

4.1.4 Side Panel (Left)
(See Figure 4.4.)

- ⑳ Air Cooling Fan
 - For cooling the inside of the STP control unit.

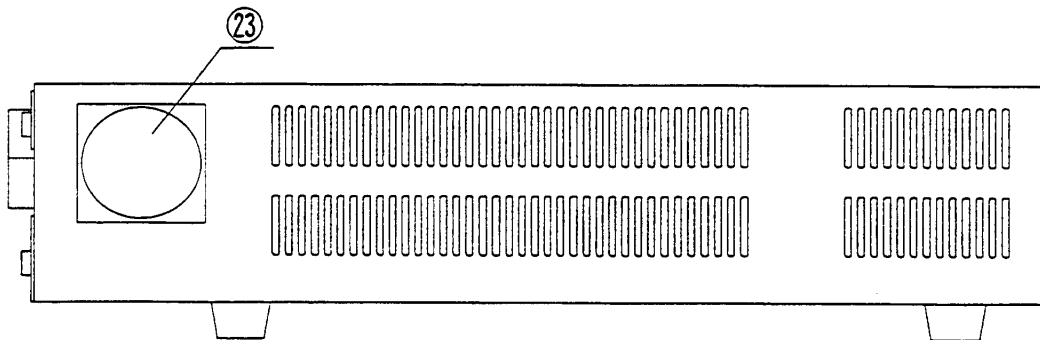

Figure 4.4 STP Control Unit Side Panel (Left)

4.2 Precautions Before Installation

4.2.1 Operating Environment

Install the STP control unit in a place meeting the following requirements:

Ambient Temperature	0 to 40 °C
Ambient Relative Humidity	30 to 95% (no dew condensing)
Environment	<ul style="list-style-type: none"> • A place free of exposure to direct sunlight. • A place free of high humidity. • A place free of dust. • A place free of salty air. • A place free of dripping water. • A place free of explosive or inflammable gas. • A place free of corrosive gas. • A place free of radiation. • A place free of strong magnetic and electric fields. • A place free of excessive vibration. • A place free of a source of electric noise.
Installation Condition	<ul style="list-style-type: none"> • Install the STP control unit horizontally (within $\pm 10^\circ$).

4.2.2 Installation Area

Leave enough space for the following in addition to that for the STP control unit (See Figure 4.5. "Peripheral Space of the STP Control Unit").

- Space for maintenance and inspection
- Space for inlet and outlet of air for cooling
 - Top and side: 5 cm or more
 - Bottom: 1.8 cm or more (height of the rubber feet)
- Space for connecting the cables
 - Rear: 15 cm or more



- ◇ The minimum bending radius of the STP connection cable is 150 mm (See Figures 15.5 and 15.6, "External Appearance of the STP Control Unit" [Cable Space]).
DO NOT excessively bend the cables and beware of any obstacles when installing the STP pump.
Also, leave enough space to install other cables without bending them excessively.

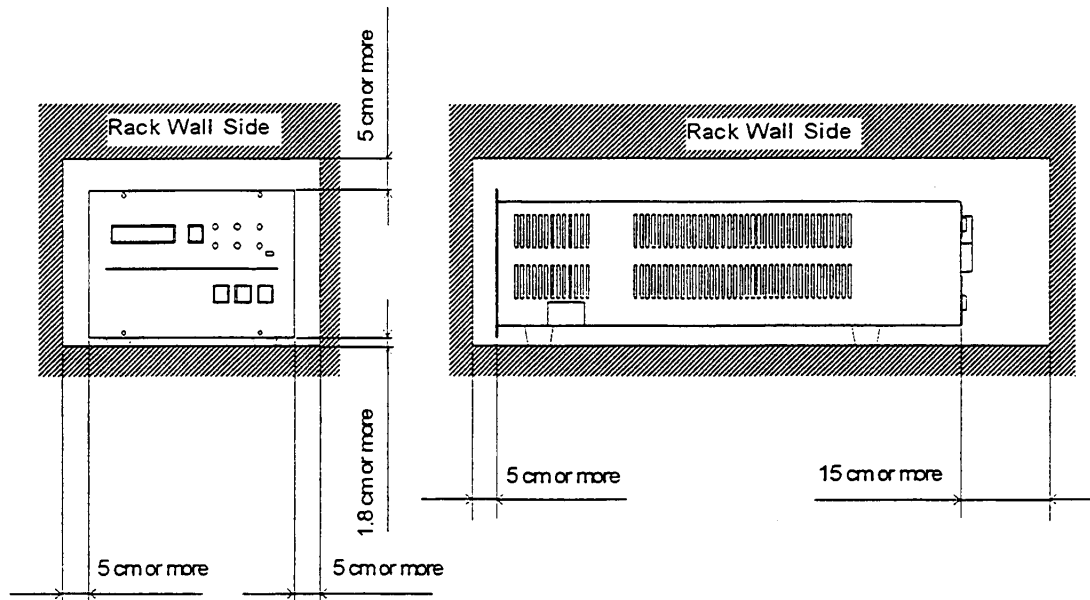

Figure 4.5 Peripheral Space of the STP Control Unit

4.3 Attaching the STP Control Unit to a Rack

The dimensions of the STP control unit front panel conform to EIA standard. Therefore, this panel can be attached to any type of commercially-available racks. Attach the STP control unit to the rack according to the following steps:

1) When attaching the STP control unit to a rack:

- Attach the front panel to a rack using the screw holes for the front panel.
- Also support the STP control unit from the bottom using a support angle or a similar tool.

2) When attaching the STP control unit to a movable rack:

- Attach the front panel to a movable rack using the screw holes for the front panel.
- To protect the STP control unit during transport, remove the rubber foot from the bottom and attach the STP control unit to the rack using the screw holes for the rubber foot.



- ◇ The STP control unit cannot be supported with only the screws on the front panel (The STP control unit is a heavy product). Always support it from the bottom. DO NOT block the bottom ventilation port.
- ◇ For the peripheral space of the STP control unit, see Figure 4.5, "Peripheral Space of the STP Control Unit."



- ◇ For the dimensions of the front panel and positions of screw holes for the rubber feet, see Figures 15.5 and 15.6, "External Appearance of the STP Control Unit."

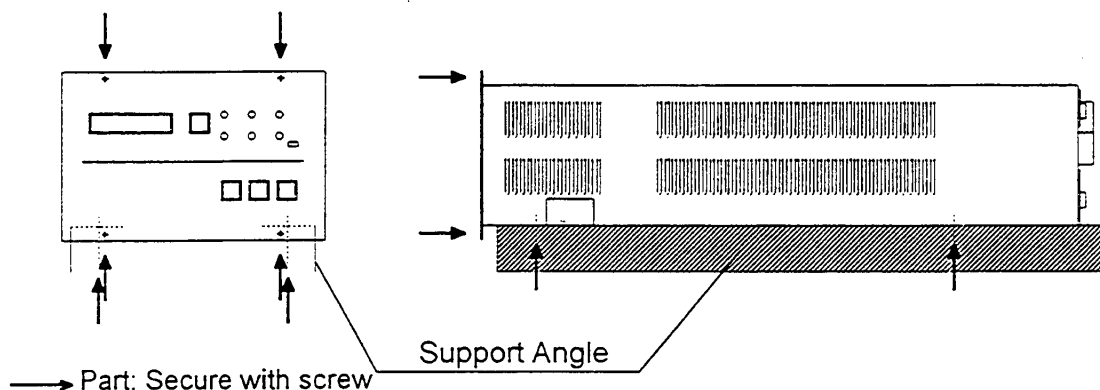

Figure 4.6 Example of Securing the STP Control Unit

4.4 Cable Connection

4.4.1 Name and Dimensions of Each Cable

(unit : mm)

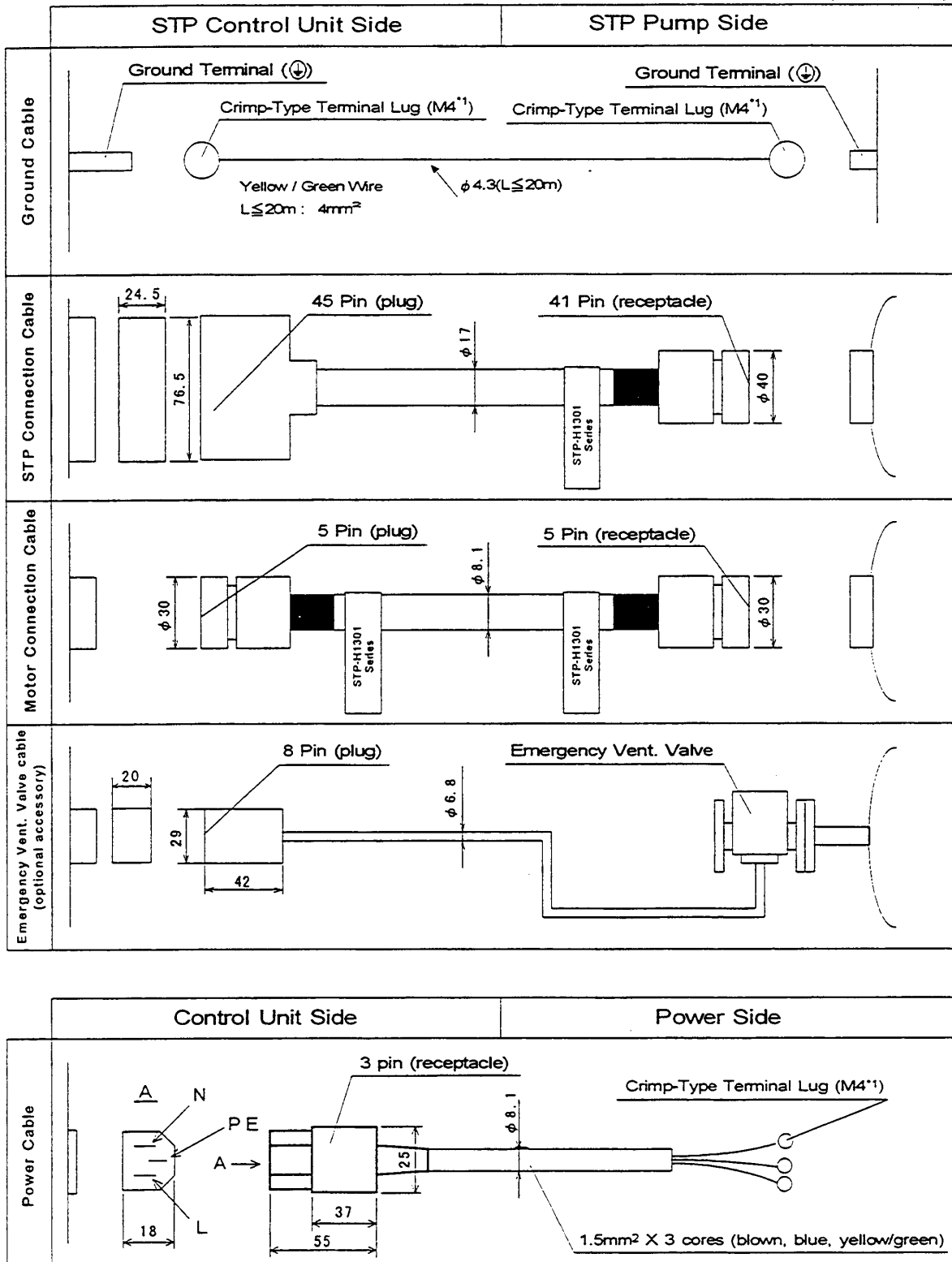

Figure 4.7 External Dimensions of Each Cable

*1: JIS

4.4.2 How to Connect the Cables



- ◇ When connecting/disconnecting cables, always power OFF the STP pump (Switch the breaker "OFF").
Failure to do so may result in electric shock or product damage.
- ◇ With each connector, align the position of the guide key and insert the pin vertically so as not to bend it.
If the pin is bent, not only may the connector not function normally, but may make the pins contact, resulting in a malfunction.
- ◇ Lock and securely tighten each connector and screw.
- ◇ DO NOT apply voltage to each pin and DO NOT cause any short-circuiting between pins.
- ◇ Connect each cable securely. DO NOT place heavy objects on the cables nor bend them excessively.
Support each cable so as not to apply direct force to the connectors or terminals.
If any problem occurs in cables, connectors or terminals, the STP pump may not function normally.

1) Connecting the Ground Cable

Connect the ground cable (yellow/green) between the ground terminal of the STP pump and the ground terminal of the STP control unit.

When the resistance between the ground terminals is less than 0.1 Ω , it is not necessary to connect the ground cable after installing the STP pump and the STP control unit.



- ◇ First, connect the ground cable. Next, connect other cables.
- ◇ When the resistance between the ground terminals is over 0.1 Ω , always connect the ground cable. Failure to do so may result in electric shock.

2) Connecting the STP Connection Cable

Connect the receptacle side of the STP connection cable to the STP connector of the STP pump and connect the plug side to "P.CONNector CON2" of the STP control unit.



- ◇ Always use the STP pump and STP control unit with the same model name and serial number, which are specified on their own name plate. If you plan to use the units having the same model name but different serial numbers or to change the length of the STP connection cable, the tuning is required. Perform the tuning by reference to Section 9, "Tuning." If the units are used without tuning, they may not operate normally.
If you plan to use the units having different model names, they may not be used even when the turning is performed. In the latter case, contact Service office.
- ◇ Use the STP connection cable that has a label affixed



The use of different cables may result in product damage.

3) Connecting the Motor Connection Cable

Connect the receptacle side of the motor connection cable to the motor connector of the STP pump and connect the plug side to "MOTOR CON3" of the STP control unit.



- ◇ Use the motor connection cable that has a label affixed

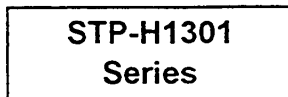

The use of different cables may result in product damage.

4) Connecting the Emergency Vent. Valve Cable (Optional Accessory)

Connect the emergency vent. valve to the purge port of the STP pump and the connector to "LEAK VALVE CON6" of the STP control unit (See Section 3.3.7. "Connecting the Emergency Vent. Valve").

Set dip switch 6 of DIP-B on the top panel of the STP control unit to the "ON" position (See Section 4.1.3. "Top Panel").



- ◇ If the STP pump is delivered with the emergency vent. valve attached, dip switch 6 of DIP-B switch is factory-set to "ON."

5) Connecting the Power (Primary Side) Cable

Connect the power cable to the "AC POWER CON1" on the STP control unit rear panel as shown in Table 4.2.

Secure the power cable connector to the STP control unit rear panel using the cable fitting tool (See Figure 4.8).

Table 4.2 Connecting Power Cable

CON1 Pin No.	Cable Color	Remarks	Rear Panel "AC POWER" Outline of connector
L	Brown	Single phase 200 to 240 V AC ±10% (for 200 V specification) Both 50/60 Hz	
N	Blue		
PE	Yellow/Green	Ground	



- ◇ Confirm the power voltage on the name plate.
- ◇ Connect the power cable securely to prevent incorrect wiring.
- ◇ DO NOT apply surge voltage exceeding 1 kV to the input power line.
- ◇ Always ground the power cable to prevent electric shock.

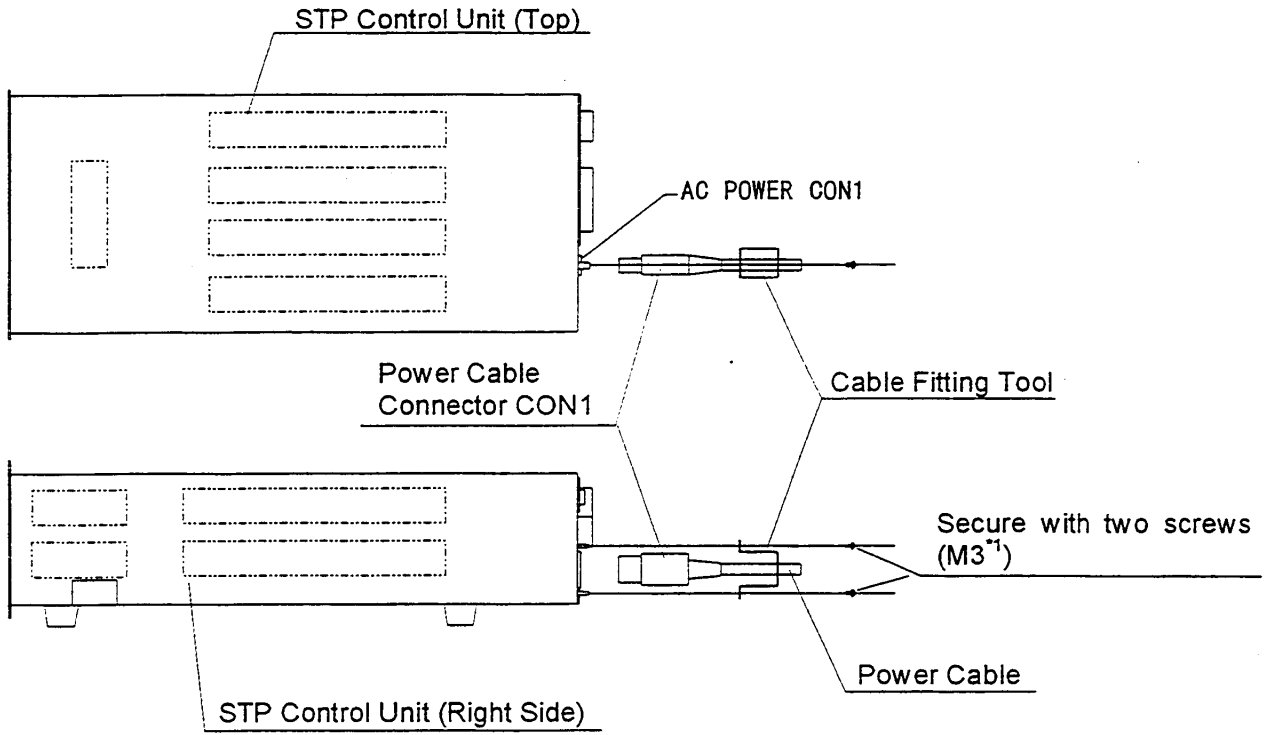

Figure 4.8 How to Secure Power Cable

*1: JIS

Section 5 How to Start/Stop the STP Pump



- ◇ NEVER connect or disconnect any cables while the power is ON.
- ◇ NEVER turn the primary power OFF (Switch the breaker "OFF") while the STP pump is in rotation.
- ◇ DO NOT release the inlet port flange or outlet port flange into the atmosphere while the STP pump is in rotation.

5.1 Before Starting

After completing installation, piping, leakage test of the STP pump, installation of the STP control unit, and wiring of cables, the STP pump is ready for start. Check the following items before starting:

- 1) Are the STP pump and the STP control unit secured according to the appropriate method?
- 2) Is the power cable connected correctly to the power supply?
- 3) Is the power voltage selected properly?
- 4) Are the ground cable, the STP connection cable, the motor connection cable, and the emergency vent. valve cable securely connected?
Are each terminal and each connector securely locked?
- 5) Is the label affixed correctly to the STP connection cable and the motor connection cable?

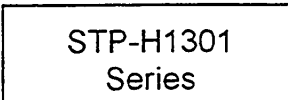

- 6) Is the serial number of the STP pump the same as that of the STP control unit? If they are different, perform the tuning according to Section 9. "Tuning."
- 7) Did you change the STP connection cable length? If you did, perform the tuning by reference to Section 9. "Tuning."

5.2 Starting/Stopping Time

Starting time: Approx. 7 minutes after start operation.

Stopping time: Approx. 8 minutes after stop operation.

If the rotational speed does not attain the rated speed within approx. 15 minutes, the "FAILURE" lamp lights and the LCD displays "OVERLOAD." Before restarting the STP pump, always check whether or not there is leakage from the piping or the vacuum equipment and also confirm the capacity and the START state of the auxiliary pump.



- ◇ When start/stop operations are frequently performed, the STP pump may overheat. Avoid doing so.

5.3 Start Procedures

Start the auxiliary pump before or simultaneously with start of the STP pump. Open the vacuum valve located at the outlet port flange side after starting the auxiliary pump.



- ◇ DO NOT open the vacuum valve without operating the auxiliary pump. Depending upon the type of the auxiliary pump, doing so may cause a reverse flow of oil, which could contaminate the inside of the STP pump.

5.4 Stop Procedures

Close the vacuum valve located at the outlet port flange side just before or after stopping the STP pump.

After closing the valve, stop the auxiliary pump.



- ◇ DO NOT stop the auxiliary pump without closing the vacuum valve. Depending upon the type of the auxiliary pump, doing so could cause a reverse flow of atmospheric air into the STP pump, which may result in a malfunction.



- ◇ DO NOT stop the auxiliary pump without closing the valve. Depending upon the type of the auxiliary pump, doing so may cause a reverse flow of oil, which could contaminate the inside of the STP pump.

There are two methods of operating the STP pump: **MANUAL** and **REMOTE**.

Select one which fits your vacuum equipment.

5.5 Manual Operation

(See Figure 5.1.)

Slide the "MANUAL/REMOTE" changeover switch on the STP control unit front panel to the position opposite to "ON." At this time, the "REMOTE" lamp is off.

5.5.1 Powering ON

- 1) Switch "ON" the breaker on the rear panel.
(To prevent incorrect operation, a metal fitting is attached to the breaker. Loosen the screw, lift the metal fitting, and secure it.)
The magnetic bearing functions and the rotor levitates (POWER ON state).
The "POWER" lamp lights.
- 2) The STP control unit executes the self test. If no error is found, the LCD displays "LEVITATION."

5.5.2 Starting the STP Pump

- 1) Press the "START" switch on the front panel to start and accelerate the STP pump. The "ACCEL." lamp lights. The LCD displays the current rotational speed in "ACCEL: ***00rpm" in units of 500 rpm (ACCELERATION state).
- 2) When the STP pump attains the rated speed of rotations, the "ACCEL." lamp goes out, and the "NORMAL" lamp lights. Also, the LCD displays "NORMAL: ***00rpm" (NORMAL OPERATION state).



- ◇ The STP pump can be manually started only when the LCD displays "LEVITATION" or "BRAKE: ***00rpm."
In the case of another message displayed, press the "SELECT" switch one or more times until "LEVITATION" or "BRAKE: ***00rpm" is displayed.
- ◇ Although the STP pump sounds for several seconds while it is accelerating, this is not an indication of abnormality.

5.5.3 Stopping the STP Pump

- 1) Press the "STOP" switch on the front panel to stop the STP pump. The "NORMAL" lamp or "ACCEL." lamp goes out, and the "BRAKE" lamp lights (BRAKE state).
(The "BRAKE" lamp does not light when the number of rotations is less than 500 rpm.)
- 2) The "BRAKE" lamp goes out when the number of rotations goes below 500 rpm.



- ◇ The STP pump can be stopped with any message displayed on the LCD

5.5.4 Starting the STP Pump after Stopping

Press the "START" switch on the front panel to reaccelerate the STP pump. The STP pump can be reaccelerated even while it is stopping.



- ◇ The STP pump can be reaccelerated only when the LCD displays "LEVITATION" or "BRAKE: ***00rpm."

5.5.5 Powering OFF

Switch "OFF" the breaker on the rear panel when all three lamps of "ACCEL.," "NORMAL," and "BRAKE" are off.

The magnetic bearing stops, the rotor lands, and the "POWER" lamp goes out (POWER OFF state).



- ◇ NEVER switch OFF the breaker when any lamp of "ACCEL.," "NORMAL," and "BRAKE" is on. Doing so causes such a state as a power failure.

5.5.6 Starting the STP Pump after a Safety Function Operates

A safety function operates when an abnormality/error occurs in the STP pump or peripheral equipment. To restart the STP pump, remove the cause of the abnormality/error after the "BRAKE" lamp goes out, and press the "RESET" switch. The "FAILURE" lamp goes out and the safety function is released (RESET operation). Then, press the "START" switch.

For the safety functions and troubleshooting, see Section 6. "Safety Functions When an Abnormality/Error Occurs" and Section 14. "Troubleshooting."

5.6 Remote Operation

(See Figure 5.1.)

(Read through Section 8. "Remote Input/Output Signal Connector" before use.)

Slide the "MANUAL/REMOTE" changeover switch on the STP control unit front panel to "ON." The "REMOTE" lamp lights.

5.6.1 Powering ON

- 1) Switch "ON" the breaker on the STP control unit rear panel.
(To prevent incorrect operation, a metal fitting is attached to the breaker. Loosen the screw, lift the metal fitting, then secure it.)
The magnetic bearing functions and the rotor levitates (POWER ON state).
The "POWER" lamp lights.
- 2) The STP control unit executes the self test. If no error is found, the LCD displays "LEVITATION."

5.6.2 Starting/Stopping the STP Pump

There are two methods of starting/stopping the STP pump. Use one of them.

Table 5.1 Starting/Stopping the STP Pump during Remote Operation (I/O CON4)

Method	Starting the Pump	Stopping the Pump
1	1) Short the circuit between ①-⑳ 2) Short the circuit between ③-㉑ for 0.3 seconds or more. However, when inputting this START signal simultaneously with switching "ON" the breaker on the rear panel, continue to short the circuit between ③-㉑ for 10 seconds or more.	Open the circuit between ①-㉑
2	Short the circuit between ①-③.	Open the circuit between ①-③.



- ◇ The STP pump can be started by remote operation with any message displayed on the LCD.
- ◇ Although the STP pump sounds for several seconds while it is accelerating, this is not an indication of abnormality.

5.6.3 Starting the STP Pump after Stopping

Perform the start operation to reaccelerate the STP pump. See Section 5.6.2, "Starting/Stopping the STP Pump."

The STP pump can be reaccelerated even while it is stopping.



- ◇ The STP pump can be reaccelerated by remote operation with any message displayed on the LCD.

5.6.4 Powering OFF

Switch "OFF" the breaker on the rear panel when all three lamps of "ACCEL.," "NORMAL," and "BRAKE" are off.

The magnetic bearing stops, the rotor lands, and the "POWER" lamp goes out (POWER OFF state).



- ◇ NEVER switch OFF the breaker when any lamp of "ACCEL.," "NORMAL," and "BRAKE" is on. Doing so causes such a state as a power failure.

5.6.5 Starting the STP Pump after a Safety Function Operates

A safety function operates when an abnormality/error occurs in the STP pump or peripheral equipment. To restart the STP pump, remove the cause of the abnormality/error after the "BRAKE" lamp goes out, and perform the operation shown in Table 5.2. The "FAILURE" lamp goes out and the safety function is released (RESET operation). Then, restart the STP pump.

For the safety functions and troubleshooting, see Section 6, "Safety Functions When an Abnormality/Error Occurs" and Section 14, "Troubleshooting."

Table 5.2 Reset Operation during Remote Operation (I/O CON4)

Method	Reset Operation
1	Short the circuit between ①-② for 0.3 seconds or more.

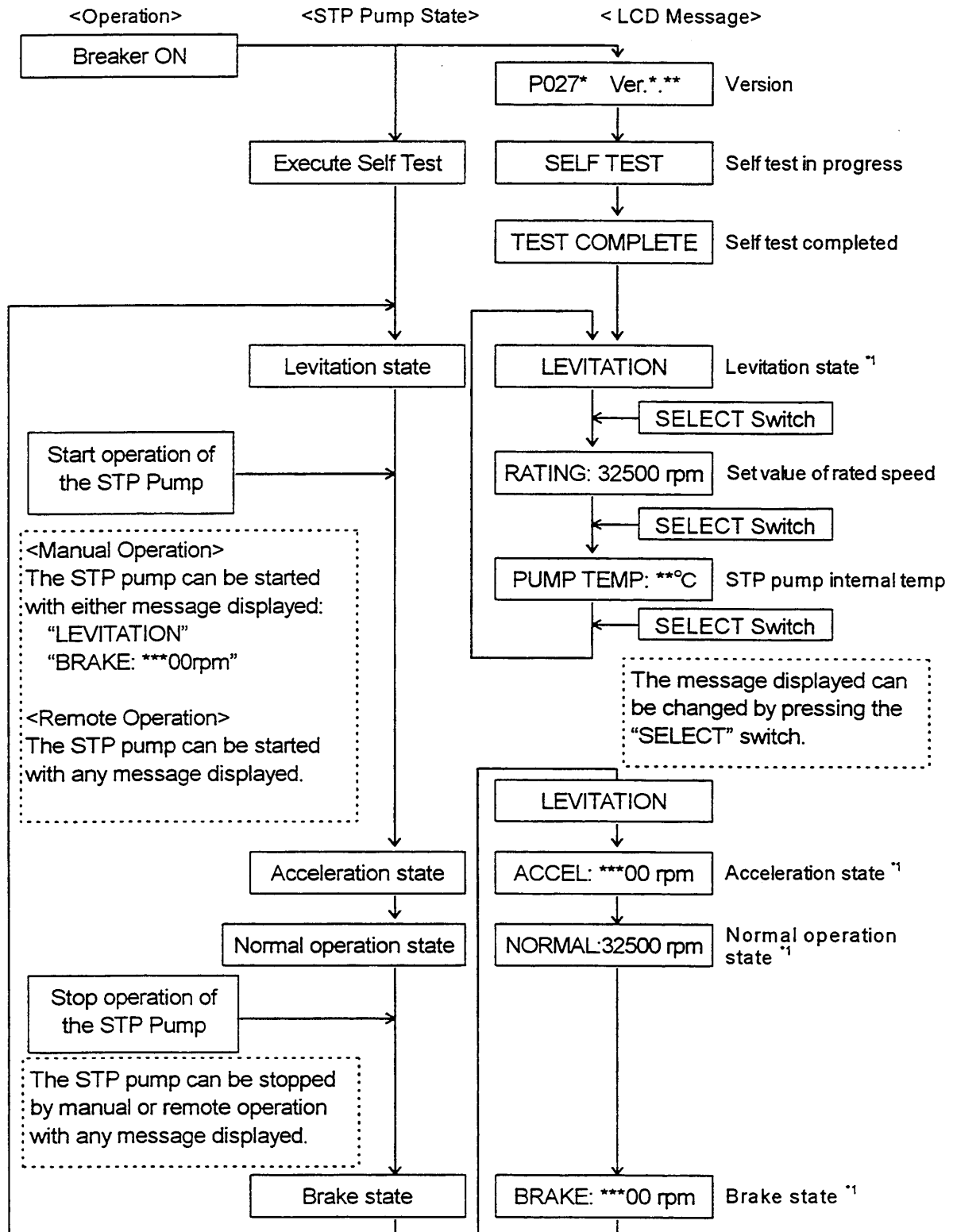

Figure 5.1 STP Pump Operation Procedures

*1: When the "SELECT" switch is pressed with this message displayed, the message changes to "RATING:32500 rpm," and when pressed again, to "PUMP TEMP:**°C."

Section 6 Safety Functions When an Abnormality/Error Occurs

The STP pump is provided with safety functions for various abnormalities/errors. When an abnormality/error occurs in the STP pump or STP control unit, a safety function operates with the "FAILURE" lamp lit, and an alarm signal is output from remote output pins. Also, the LCD displays an error message. (See Tables 6.3 and 6.4. "Safety Functions.")

If an ampersand "&" is shown at the right of the displayed error message, it indicates that one or more errors occur. Press the "SELECT" switch to display another error message (The "SELECT" switch can also be used during remote operation).

Example)

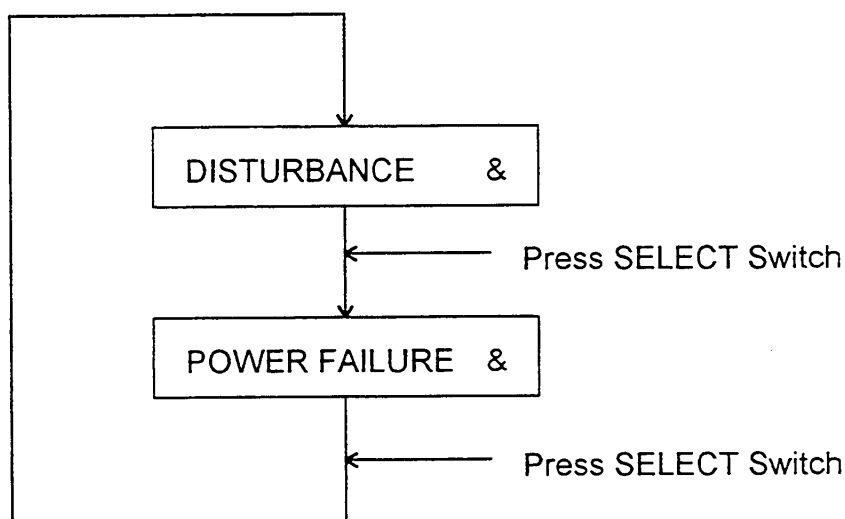

For troubleshooting, see Section 6.2. "Restarting after any Safety Function Operates" and Section 14. "Troubleshooting."

6.1 Safety Functions

6.1.1 Power Failure

< I . Operation at a Power Failure >

When the power voltage drops below 170 V due to a power failure or other, the normal operation of the magnetic bearing is maintained using the regenerative energy of the rotating rotor (backup operation during a power failure).

1) When the number of rotations is 12,000 rpm or more at a power failure:

- i. The STP control unit detects any power failure of 2 seconds or more and the STP pump decelerates.

At this time, the "POWER" lamp goes out and the "FAILURE" lamp lights. The LCD displays "POWER FAILURE." Also, an alarm signal is output from I/O CON4 ALARM OUT pins ③③-①④ and ③③-①⑤.

When the number of rotations goes down to 12,000 rpm, the backlight of the LCD goes out. The emergency vent. valve, if attached to the STP pump, is opened to introduce gases.

When the number of rotations goes down to approx. 11,000 rpm, the rotor lands on the touch down bearing and stops. The "FAILURE" lamp goes out and the LCD is turned off. Also, the alarm signal output is reset.

- ii. The STP control unit does not detect a power failure of less than approx. 2 seconds, continuing rotating the STP pump.

2) When the number of rotations is 11,000 rpm or more and less than 12,000 rpm at a power failure:

The STP control unit detects a power failure of approx. 0.02 to 0.14 seconds and the STP pump decelerates.

At this time, the "POWER" lamp goes out and the "FAILURE" lamp lights. The LCD displays "POWER FAILURE." Also, an alarm signal is output from I/O CON4 ALARM OUT pins ③③-①④ and ③③-①⑤.

The backlight of the LCD goes out immediately after the power failure is detected. The emergency vent. valve, if attached to the STP pump, is opened to introduce gases.

When the number of rotations goes down to approx. 11,000 rpm, the rotor lands on the touch down bearing and stops. The "FAILURE" lamp goes out and the LCD is turned off. Also, the alarm signal output is reset.

NOTICE

- ◇ A power failure is detected faster the less the number of rotations at a power failure.

- 3) When the number of rotations is less than approx. 11,000 rpm at a power failure:

The STP control unit does not detect the power failure. The rotor lands on the touch down bearing and stops.

<II. Operation after a Power Recovery>

- 1) MANUAL operation

The magnetic bearing operation and LED lamp and LCD messages are recovered after a power recovery. The "FAILURE" lamp goes out.

- The STP pump continues decelerating even after a power recovery. Press the "START" switch to reaccelerate the STP pump.

- 2) REMOTE operation

The magnetic bearing operation and LED lamp and LCD messages are recovered after a power recovery. The "FAILURE" lamp goes out.

- When the START signal is input to the REMOTE input pin after a power recovery, the STP pump reaccelerates.
- When the START signal is not input to the REMOTE input pin after the power recovery, the STP pump continues the BRAKE operation.



- ◇ Establish a sequence so that the power can be supplied to the STP control unit immediately after a power recovery.

Table 6.1 shows the states of LCD, LED lamps, and REMOTE output signals at a power failure.

Also, Table 6.2 shows the operations of the STP pump after a power recovery.

Table 6.1 States of Lamps and REMOTE Output Signals at a Power Failure

Number of rotations (rpm)	LCD		LED lamps		REMOTE output signals (I/O CON4)	
	Message	Backlight	POWER lamp	FAILURE lamp	Power ON signal	ALARM signal
12,000 or more	POWER FAILURE	ON	OFF	ON	OFF	ON
11,000 or more and less than 12,000	POWER FAILURE	OFF	OFF	ON	OFF	ON
Less than 11,000	OFF	OFF	OFF	OFF	OFF	OFF

Table 6.2 Operations of the STP Pump after a Power Recovery

Number of rotations (rpm)	Duration of power failure	MANUAL operation	REMOTE operation	
		STP pump operation after a power recovery	"START" REMOTE signal input after a power recovery	STP pump operation after a power recovery
12,000 or more	Approx. 2 sec. or more	Deceleration/Stop	Yes	Reacceleration
			No	Deceleration/Stop
	Less than approx. 2 sec.	Continues as before.		
Less than 12,000	Approx. 0.02 to 0.14 sec.* ¹	Deceleration/Stop	Yes	Reacceleration
			No	Deceleration/Stop
	Less than the above	Continues as before.		

*¹: A power failure is detected faster the less the number of rotations at a power failure.

6.1.2 Abnormal State of Magnetic Bearing

When the magnetic bearing does not function normally due to a breakage of the STP connection cable, disconnection of connectors or any abnormality/error of the STP control circuit, the rotor falls on the touch down bearing and stops.

The "FAILURE" lamp lights and the LCD displays error message "DISTURBANCE."

The emergency vent. valve, if attached to the STP pump, is opened to introduce gases.



- ◇ When an abnormality/error occurs in the magnetic bearing, check the STP pump as well as the STP control unit and contact Service office.

6.1.3 Excessive Vibration

When serious vibration or mechanical shock causes the rotor to touch the touch down bearing (due to external vibration/impact, intrusion of atmosphere or foreign materials into the STP pump or rotor imbalance), the STP pump decelerates and stops.

The "FAILURE" lamp lights and the LCD displays error message "DISTURBANCE."

The emergency vent. valve, if attached to the STP pump, is opened to introduce gases.

6.1.4 Motor Driver Overload

When the STP pump does not attain the rated speed within approx. 15 minutes after starting or when the ACCELERATION state remains unchanged during operation for approx. 15 minutes, the STP pump decelerates and stops.

The "FAILURE" lamp lights and the LCD displays error message "OVERLOAD."

6.1.5 Overheating Inside the STP Pump

When the temperature of the motor inside the STP pump exceeds 110°C due to an abnormal baking temperature or overload operation, the STP pump decelerates and stops.

The "FAILURE" lamp lights and the LCD displays error message "PUMP OVERTEMP."

6.1.6 Overheating Inside the STP Control Unit

When the temperature inside the STP control unit exceeds 70°C due to a failure in the air cooling fan, external heat source, and other, the STP pump decelerates and stops.

The "FAILURE" lamp lights and the LCD displays error message "CONTROLLER OT."

6.1.7 Overspeed

When the rotational speed of the STP pump exceeds 35,000 rpm due to a failure in the motor driver, the breaker in the STP control unit switches "OFF." The STP pump has no power supplied and stops.

When the number of rotations goes down to 12,000 rpm, the emergency vent. valve, if attached to the STP pump, is opened to introduce gases.

The "FAILURE" lamp lights and the LCD displays error message "OVERSPEED."

6.1.8 TMS Breaker OFF (When TMS Unit is Used)

When the breaker in the TMS control unit switches "OFF," the STP pump decelerates and stops.

The "FAILURE" lamp lights and the LCD displays error message "TMS BRAKER OFF."

6.1.9 TMS Abnormal (When TMS Unit is Used)

When a temperature abnormality occurs in the TMS unit, the STP pump decelerates and stops.

The "FAILURE" lamp lights and the LCD displays error message "TMS ALARM."



- ◇ For TMS unit operations, refer to the Instruction Manual of the TMS unit.

6.2 Restarting after any Safety Function Operates

6.2.1 In Case of a Power Failure

Establish a sequence so that the power can be supplied to the STP control unit immediately after a power recovery.

The "FAILURE" lamp goes out.

6.2.2 In Other Cases

< I . MANUAL OPERATION >

- i. After confirming that the "BRAKE" lamp goes out and the STP pump stops, remove the probable cause of the abnormality.
- ii. Press the "RESET" switch to turn off the "FAILURE" lamp (RESET operation).
- iii. Press the "START" switch to restart the STP pump. Check if the STP pump operates correctly.

< II . REMOTE OPERATION >

- i. After confirming that the "BRAKE" lamp goes out and the STP pump stops, remove the probable cause of the abnormality.
- ii. Perform the RESET operation according to Section 5.6.5, "Starting the STP Pump after a Safety Function Operates" to turn off the "FAILURE" lamp.
- iii. Restart the STP pump according to Section 5.6.2, "Starting/Stopping the STP Pump." Check if the STP pump operates correctly.



- ◇ When disconnecting cables from the STP pump and/or the STP control unit to perform troubleshooting and take the necessary action, confirm that the STP pump stops, turn OFF the primary power (Switch the breaker "OFF"), then disconnect the cables.
- ◇ If the RESET operation does not turn off the "FAILURE" lamp, confirm that the STP pump stops, turn OFF the primary power (Switch the breaker "OFF"), then turn ON the primary power (Switch the breaker "ON").

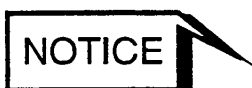

- ◇ For probable causes and troubleshooting, see Section 14, "Troubleshooting."

6.3 Operation of the Emergency Vent. Valve (Optional Accessory)

The emergency vent. valve is opened when the number of rotations goes down to approx. 12,000 rpm at a power failure or overspeed is detected.

The emergency vent. valve is also opened immediately after an abnormality/error in the magnetic bearing, excessive vibration or any other abnormality/error is found. Gases (dry N₂ gases or atmospheric air) are introduced through the emergency vent. valve into the STP pump.

Attach the emergency vent. valve taking care of the following NOTICE:



- ◇ It is recommended to introduce dry N₂ gases to prevent the STP pump and vacuum equipment from getting contaminated. The pressure for introducing gas ranges from zero (atmospheric pressure) to 0.5 kgf/cm² (gauge pressure).
- ◇ The rotor comes into contact with the touch down bearing, with the emergency vent. valve opened. This may damage the rotor or the touch down bearing.
To stop the STP pump in a very short time, design an appropriate vacuum exhaust system that closes the vacuum valve at the outlet port flange when the emergency vent. valve is opened. This prevents the rotor and the touch down bearing from being damaged.

Table 6.3 Safety Functions

[E.V. used herein is the abbreviation for Emergency Vent.]

Abnormality/ Error	Operation state of safety function s	Lamp indication	LCD	REMOTE output signal	State of the STP pump	Probable causes of an abnormality/error	Reset by RESET switch
Power failure (For details, see Section 6.1.1, "Power Failure.")	Power failure time: 2 seconds or more	"FAILURE" lights. "POWER" goes out.	"POWER FAILURE"	"ALARM" "POWER ON" output cut-off	The magnetic bearing continues to operate using regenerative energy. The STP pump decelerates and stops. The E. V. valve is opened at approx. 12000rpm. The rotor lands on the touch down bearing at approx. 11000rpm.	Power failure. Power cable breakage. Power cable disconnection.	Impossible
Abnormal magnetic bearing	Rotor descends onto the touch down bearing.	"FAILURE"	"DISTURBANCE"	"ALARM"	The STP pump stops. The E.V. valve is opened.	STP connection cable breakage. STP connection cable disconnection. Abnormal control circuit.	Possible
Excessive vibration	Rotor vibration: 100 μ m 0-P or more	"FAILURE"	"DISTURBANCE"	"ALARM"	The STP pump decelerates and stops. The E.V. valve is opened.	External vibration and impact. Intrusion of atmospheric air. Intrusion of foreign materials.	Possible
Overload of motor driver	Excessive current flows in the motor.	"FAILURE"	"OVERLOAD"	"ALARM"	The STP pump decelerates and stops.	Leakage from the vacuum equipment or piping. Insufficient pressure at inlet and outlet port sides. Failure of starting of the auxiliary pump.	Possible

Abnormality/ Error	Operation state of safety function s	Lamp indication	LCD	REMOTE output signal	State of the STP pump	Probable causes of an abnormality/error	Reset by RESET switch
Overheating inside the STP pump	Temperature of the STP pump motor: 110 °C or more	"FAILURE"	"PUMP OVERTEMP"	"ALARM"	The STP pump decelerates and stops.	Abnormal baking temperature. Insufficient cooling. Leakage of vacuum equipment or piping. Continuous repetition of startup/stop. Extraordinarily-high temperature.	Possible
Overheating inside the STP control unit	70 °C or more inside the STP control unit.	"FAILURE"	"CONTROLLER OT"	"ALARM"	The STP pump decelerates and stops.	Failure in the cooling fan. Shielding of cooling air inlet and ventilation port. Extraordinarily-high temperature.	Possible
Overspeed	Rotational speed of the STP pump: 35000 rpm or more.	"FAILURE"	"OVERSPEED" or "MOTOR RA"	"ALARM" "POWER ON" output cut-off	Breaker OFF. Power failure state is entered and the STP pump stops. The E.V. valve is opened at approx. 12000 rpm.	Failure in the motor driver.	Impossible

Table 6.4 Safety Functions (When the TMS Unit is Used)

Abnormality/ Error	Operation state of safety functions	Lamp indication	LCD	REMOTE output signal	State of the STP pump	Probable causes of an abnormality/error	Reset by RESET switch
TMS control unit breaker OFF	TMS control unit main breaker OFF	"FAILURE"	"TMS BREAKER OFF"	"ALARM"	The STP pump decelerates and stops.	Leakage. Overcurrent. (For details, refer to the Instruction Manual of the TMS unit.)	Impossible
Failure of TMS unit	Abnormal temperature	"FAILURE"	"TMS ALARM"	"ALARM"	The STP pump decelerates and stops.	Abnormal cooling water. Heater disconnected. (For details, refer to the Instruction Manual of the TMS unit.)	Impossible

Section 7 Gas Suction, Cooling and Baking the STP Pump

7.1 Gas Suction



- ◇ When sucking gases, they may remain in the STP pump. Introduce a purge gas and then exhaust all gasses. Residual gases in the STP pump may cause an accident when the STP pump is removed. Confirm the characteristics of gases to be used, referring to the Material Safety Data Sheet (MSDS) you obtain from the gas supplier.



- ◇ The STP-H1301 series models are chemical specific pumps; chlorine or fluorine system gases can be used with these models. When you use gases including alkaline metals, but excluding Li, gases including Ga, Hg, In, or Sn, or HBr, contact BOCET. (See Section 1.1, "Usable Gases")
- ◇ Cool the STP pump to prevent the STP pump from overheating when sucking gases (See Section 7.2, "Cooling the STP Pump").

7.1.1 How to Introduce a Purge Gas

When sucking reactive or corrosive gases, introduce a purge gas to protect the inside of the STP pump.

- 1) Connect a needle valve or a similar part to the purge port and introduce a dry N₂ gas or other gas to perform a gas purge (See Section 3.3.5. "Connecting the Purge Port").
- 2) The proper amount of the gas purge is approx. 3.4×10^{-2} Pa·m³/sec (20SCCM). The allowable gas pressure ranges from zero (atmospheric pressure) to 0.5 kgf/cm² (gauge pressure).



- ◇ When not using the purge port, always mount the blank flange (attached at delivery).
- ◇ High-pressure at the inlet port may result in a noise. This is no abnormality/error.

7.2 Cooling the STP Pump

(See Figure 7.1.)

When sucking gases, cool the STP pump.

Also, when performing baking, always cool the STP pump.

If the TMS unit is used, cool the STP pump with the method specified for the TMS unit.

7.2.1 Water Cooling Method

- 1) Connect the cooling water pipe to the cooling water port in accordance with Figure 7.1.
- 2) The female screw PT*¹ (RC)1/4 is used in the cooling water port (See Figures 15.1 to 15.4, "External Appearance of the STP Pump").
- 3) Use connection hose of ID (internal diameter) 8 mm, and secure it to prevent water leakage.
- 4) Use cooling water under the following conditions:

Amount of water:	2 lit./min.
Temperature:	5 to 25 °C
Water pressure:	3 kgf/cm ² or less.



- ◇ Use clean water as much as possible.
Cooling water containing foreign materials may corrode or clog the cooling water pipe.
When the cooling system is clogged with foreign materials, clogs may possibly be removed by feeding cooling water reversibly.
- ◇ When the STP pump is overheated due to shortage or suspension of water, the protective function detects the overheated condition in the STP pump and stops the STP pump.
As a further safety procedure, attach a flow switch to the cooling water exit so that the STP pump stops if abnormal cooling water flow occurs (A flow switch is available on the market).
- ◇ When the STP pump is not to be used for a long period of time or it is to be moved after use, introduce compressed air from one side of the inlet/outlet port so that no water will remain inside.
- ◇ The joint for water cooling unit is made of brass. To prevent corrosion, connect the brass joint.

*1: JIS

7.3 Baking the STP Pump

To attain a less pressure in a shorter time and reduce the exhaust time, bake the vacuum equipment and STP pump.



- ◇ The surfaces of the STP pump and its peripheral equipment will become extremely hot when performing baking. NEVER touch them with bare hands.



- ◇ The TMS unit and the baking heater cannot be used together at the same time.
- ◇ When baking the STP pump, always cool it to prevent overheating (For the cooling method, see Section 7.2, "Cooling the STP Pump").
- ◇ Start baking after cooling is started.
Set the temperature of the baking heater to 120 °C or less (An optional baking heater is set to 110 °C or less).
- ◇ DO NOT suck gases during baking to prevent overheating.



- ◇ To exhaust the gas discharged from the vacuum equipment and the inner wall of the STP pump, run the STP pump during baking.

7.3.1 Attaching a Baking Heater

- 1) Attach a baking heater (optional accessory) as near as possible to the inlet port flange (See Figure 7.1. "Attaching Positions of the Cooling Unit and Baking Heater").
- 2) Affix the "Hot Surface Warning Label" to the surface of the STP pump so that the operator can see it clearly at any time (see Figure 7.1. "Attaching Positions of the Cooling Unit and Baking Heater").



- ◇ Check the rated voltage of the baking heater before use.
- ◇ Wind the baking heater around the surface of the STP pump tightly. If the baking heater is not wound tightly, the loose parts will overheat.
- ◇ Procure protective parts for the baking heater, such as an earth leakage breaker or fuses when using the baking heater (Remote terminal block TB2 incorporates fuses).
- ◇ DO NOT apply excessive force to the cable for the baking heater.

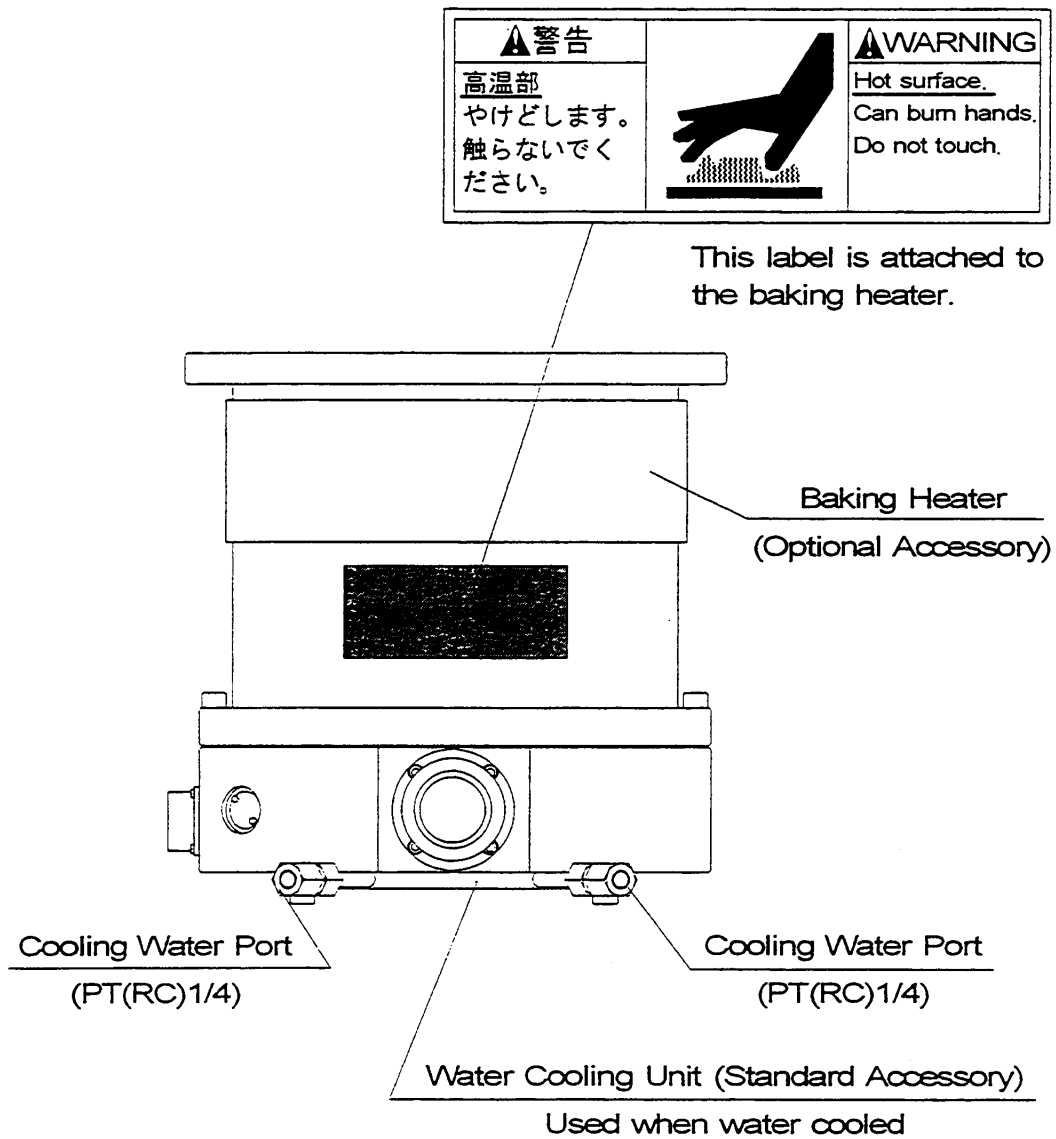
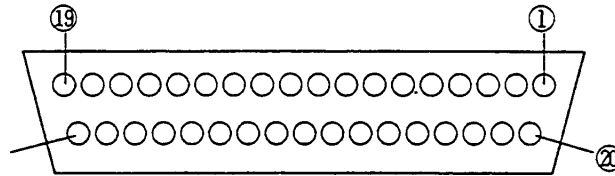

Figure 7.1 Attaching Positions of the Cooling Unit and Baking Heater

Section 8 Remote Input/Output Signal Connector

The remote input/output signal connector (I/O CON4) is used to input and output remote signals.

This connector is of D-Sub type*1 (37-pin, receptacle).



I/O CON4 Pin Arrangement



- ◇ Procure the connector for remote connection at your company.

8.1 Input Signal Pins

Use input signal pins according to Table 8.1 and Figure 8.1.



Remote input signals function during REMOTE operation only, except the ROTATION INHIBIT signal is input.

Two abbreviations are used in Table 8.1:

COM: Common IN: Input Pin

*1: D-subminiature connector (Conforms to MIL-C-24308)

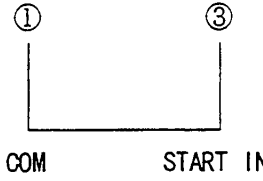
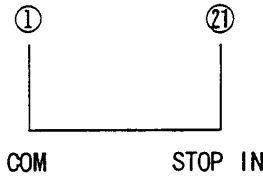
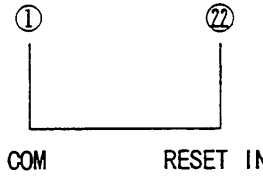
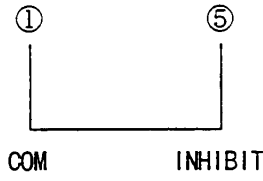
Table 8.1 I/O CON4 Input Signal Pins

Pin	Description
 <p>① ③ COM START IN</p>	<p>Pins for inputting the START signal. The following two methods are available:</p> <ol style="list-style-type: none"> 1) Short the circuits between ①-②①. Then, short the circuits between ③-②① for 0.3 seconds or more. However, when inputting this START signal simultaneously with switching "ON" the breaker on the rear panel, continue to short these pins for 10 seconds or more. 2) Short the circuits between ①-③. In this case, ②① is not used.
 <p>① ②① COM STOP IN</p>	<p>Pins for inputting the STOP signal. The STOP signal has priority over this START signal.</p> <ol style="list-style-type: none"> 1) When 1) above is used to start the STP pump, open the circuits between ①-②① to stop the STP pump. 2) When 2) above is used to start the STP pump, open the circuits between ①-③ to stop the pump.
 <p>① ②② COM RESET IN</p>	<p>Pins for inputting the abnormality RESET signal. Short the circuits between ①-②② for 0.3 seconds or more to turn off the "FAILURE" lamp.</p>
 <p>① ⑤ COM INHIBIT</p>	<p>Pins for inputting the rotation INHIBIT signal (valid in both MANUAL and REMOTE operations). When pins ①-⑤ are set to open, the STP pump does not rotate even by performing the start operation. When these pins are set to open when the pump is in rotation, the pump will stop (The pump does not rotate even by manually starting the pump). When not using this function, short the circuits between ①-⑤ or set DIP-B switch 6 to ON (See Section 4.1.3, Top Panel").</p>
<p>②, ④, ⑥, ⑦, ①⑥, ①⑦, ①⑧, ①⑨, ②①, ②③, ②④, ②⑤, ③①, ③④, ③⑤, ③⑥, ③⑦</p>	<p>These pins are not used.</p> <div style="border: 1px solid black; padding: 5px; display: inline-block;">  CAUTION </div> <p>DO NOT connect anything to these pins. Doing so may damage the STP control unit or the vacuum equipment.</p>

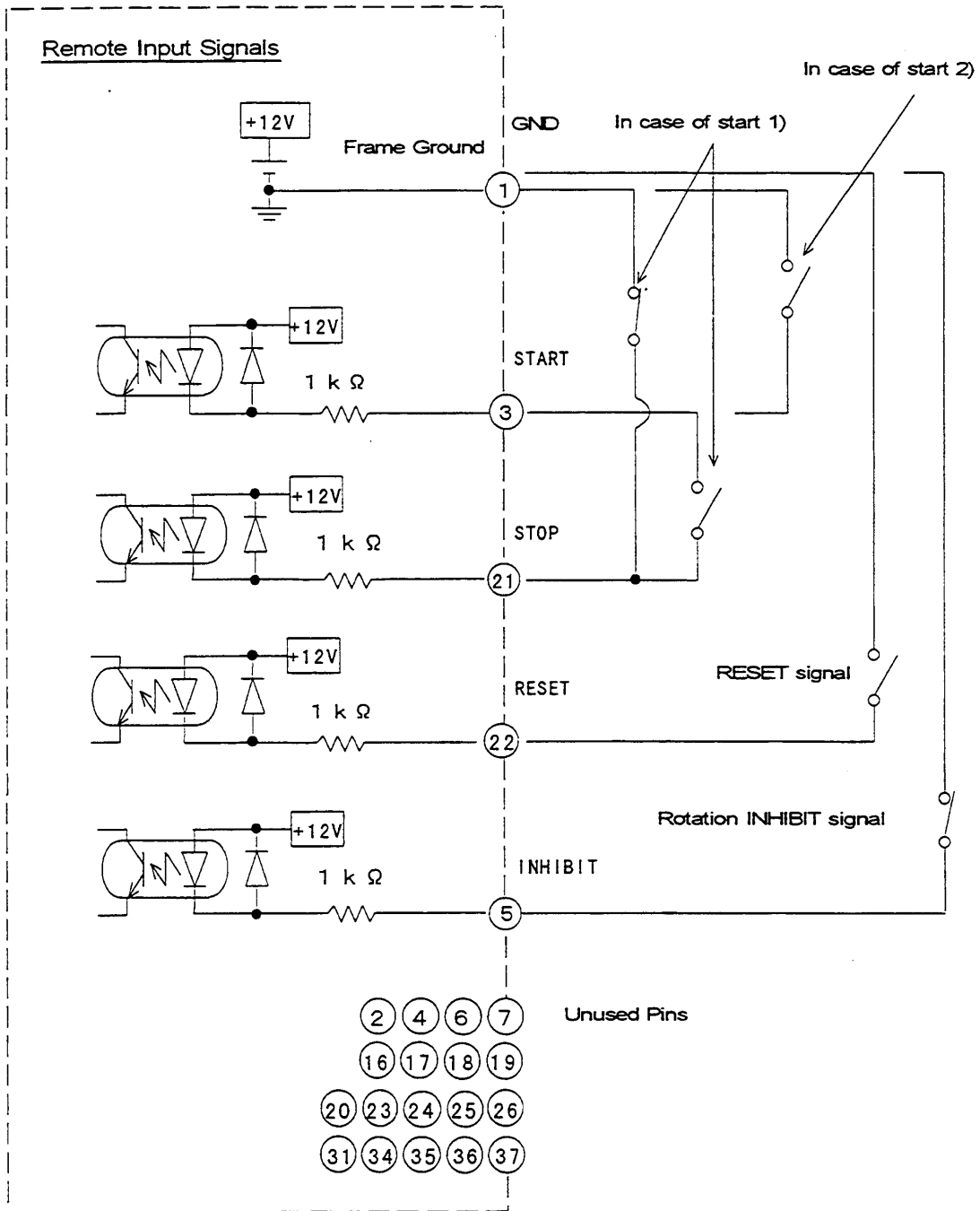

Figure 8.1 I/O CON4 Input Signal Pins

8.2 Output Signal Pins

Use output signal pins according to Table 8.2 and Figure 8.2.

Remote output signals function during MANUAL and REMOTE operations.

Four abbreviations are used in Table 8.2:

N.O: Normal Open N.C: Normal Close
 COM: Common OUT: Output Pin

Table 8.2 I/O CON4 Output Signal Pins

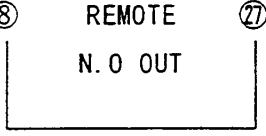
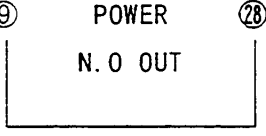
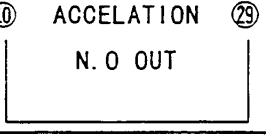
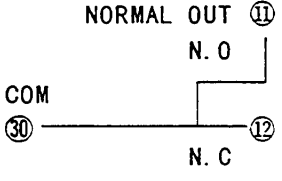
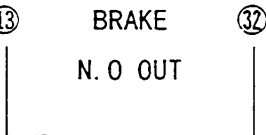
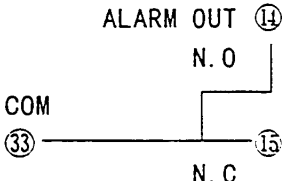
Pin	Description
	<p>Pins for outputting the STP pump REMOTE SELECTION state signal. When the MANUAL/REMOTE changeover switch on the front panel is set to ON (remote side), these pins are closed ("REMOTE" operation). However, when the number of rotations is less than 11,000 rpm during power failure backup operation, this signal is not output.</p>
	<p>Pins for outputting the POWER ON state signal. These pins are closed when the magnetic bearing functions and the rotor levitates. This output is cut OFF at a power failure.</p>
	<p>Pins for outputting the ACCELERATION state signal. These pins are closed when the STP pump is in acceleration.</p>
	<p>Pins for outputting the NORMAL OPERATION state signal. When the STP pump is in rated operation, the pins between 11-30 are closed, and the pins between 12-30 are opened.</p>
	<p>Pins for outputting the BRAKE state signal. These pins are closed when the STP pump is in brake. However, when the number of rotations is less than 11,000 rpm during power failure backup operation, this signal is not output.</p>
	<p>Pins for outputting the ALARM signal. When an abnormality/error is detected under the POWER ON state, the pins between 14-33 are closed, and the pins between 15-33 are opened. However, when the number of rotations is less than 11,000 rpm during power failure backup operation, this signal is not output.</p>

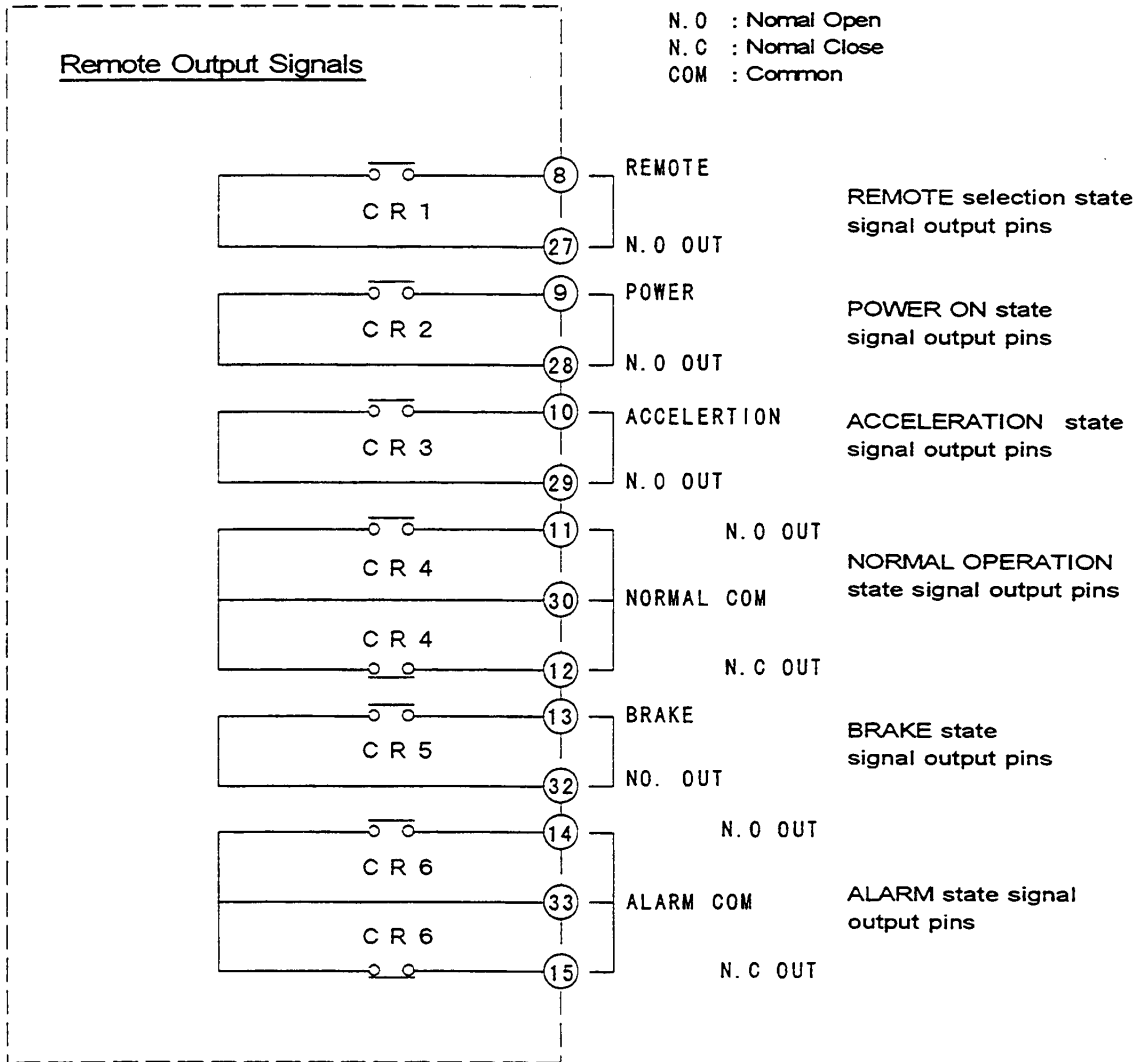

Figure 8.2 I/O CON4 Output Signal Pins

Table 8.3 shows the contact ratings for relays CR1 to 6 in Figure 8.2.

Table 8.3 Rated Contacts for Relays CR1 to 6

	Resistance Load ($\cos \Phi=1$)	Induction Load ($\cos \Phi=0.4$) ($L/R=7$ ms)
Rated Load	110 V AC 0.4 A 30 V DC 2 A	110 V AC 0.2 A 30 V DC 1 A
Rated Current	3 A	
Maximum Contact Point Current	3 A	
Maximum Open/Close Capacity	AC: 50 VA DC: 60 W	AC: 25 VA DC: 30 W
Minimum Applicable Load	10 mV DC 10 μ A	

Section 9 Tuning



- ◇ The tuning function is not available for STP-H1301C, STP-H1301L, STP-H1301WA, and STP-H1301WV.

For the STP pump, the tuning is required to align the position of levitation in the axial direction with the center of the rotor's movable range.

The tuning can be performed simply by pressing the RESE " switch on the front panel

The tuning is completed before delivery, so it is not required before use. However, re-tuning is required in the following cases in which the position of levitation may deviate from the center of the rotor's movable range:

- ◇ When changing the length of the STP connection cable (not when changing the length of the power cable or motor connection cable)
- ◇ When using the STP pump and the STP control unit which have different serial numbers

9.1 Tuning Method

- 1) Connect each cable.
- 2) Switch "ON" the breaker on the rear panel.
- 3) After the STP pump completes the self test and enter the levitation state, press the "RESET" switch on the front panel for approx. 3 seconds. The tuning starts with "TUNING!" displayed on the LCD.
- 4) When the LCD displays "TUNING!," release the "RESET" switch.
- 5) Approx. one minute later the LCD displays "TUNING COMPLETE" and returns to the message displayed in 3). This completes the tuning.



- ◇ The tuning can be performed only while the STP pump is in the LEVITATION state (It cannot be performed while the STP pump is in the ACCELERATION, NORMAL OPERATION, or BRAKE state). Also, the tuning can be performed when any message of "LEVITATION," "RATING: ***00rpm," or "PUMP TEMP: **°C" is displayed.
- ◇ When performing the tuning during remote operation, also use the "RESET" switch on the front panel. (The remote signal cannot be used for tuning.)
- ◇ Once the tuning is completed, re-tuning is not required unless the configuration (the STP pump serial number, the STP control unit serial number, and the STP connection cable length) is changed.
- ◇ Although the STP pump sounds during tuning, this is not an indication of abnormality.

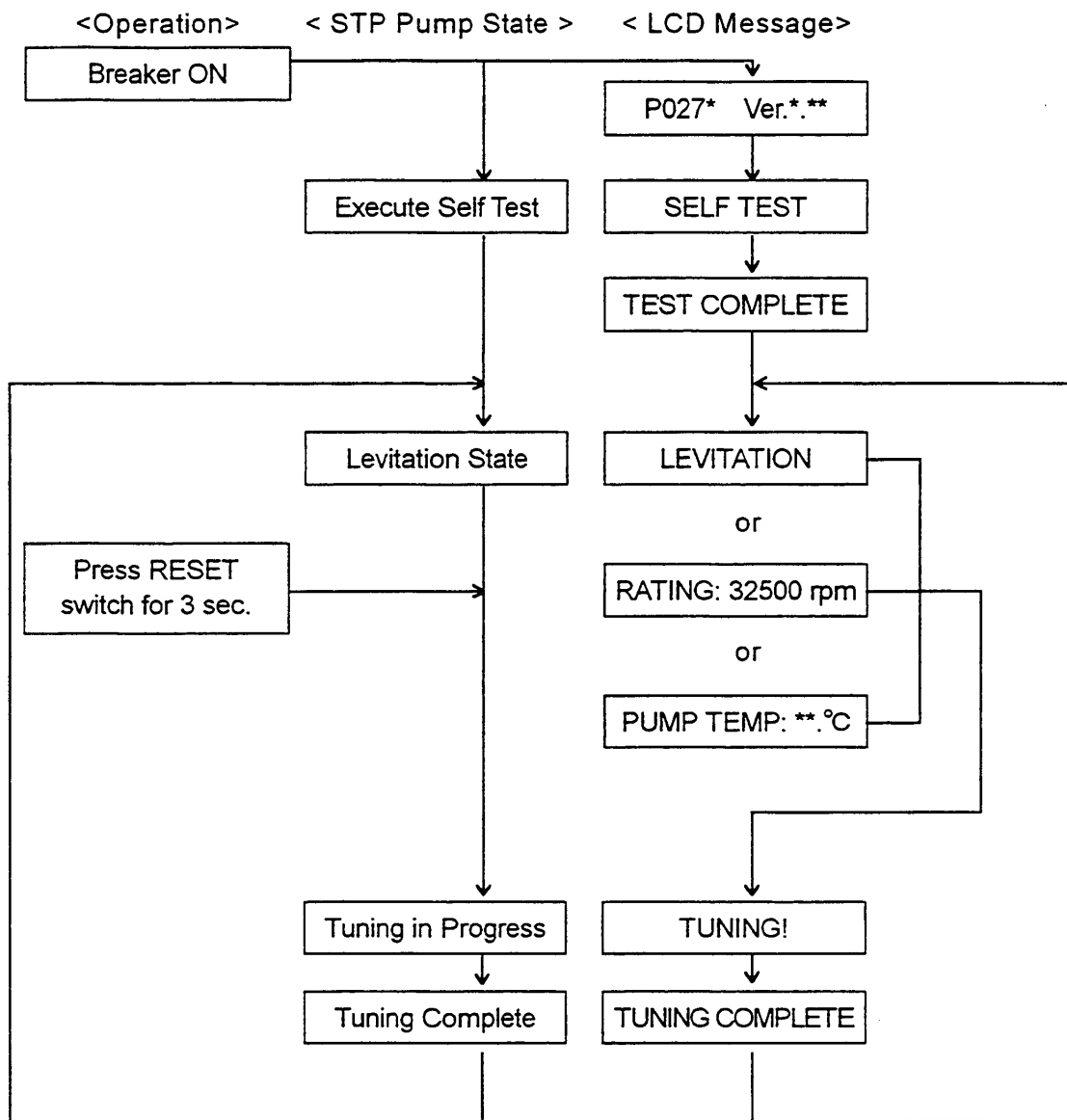

Figure 9.1 Tuning Procedures

Section 10 Operation Principle of the STP Pump

(See Figure 10.1.)

The STP-H1301 is a series of magnetically-levitated turbomolecular pumps, featuring the following:

- Oil free
- Low vibration
- High reliability

The STP pump is configured so that rotor blade ① and stator blade ② are aligned alternately in the axial direction. Gas molecules are pumped from the inlet port to the outlet port by the high speed rotation of the rotor.

The STP pump is configured with a screw channel pump and turbine blade together in the lower side of rotor blade ① for high-throughput even at a low vacuum range (a few hundred Pa (a few Torr)).

Rotor blade ① is supported by the magnetic bearing without mechanical contact. Therefore, the STP pump requires no lubrication oil unlike conventional turbomolecular pumps using ball bearings.

The magnetic bearing consists of 3 pairs of active magnetic bearings. The rotor is supported in the radial direction by 2 pairs of radial direction active magnetic bearings that consist of radial sensor ③ and radial electromagnet ④. A pair of axial direction active magnetic bearings consists of axial sensor ⑤ and axial electromagnet ⑥ to support the rotor in the axial direction. Because the rotor is supported without mechanical contact, it can rotate at low speed.

There is less heat generated from magnetic bearings because there is no friction. Therefore the STP pump requires no cooling. However, the STP pump requires water cooling during baking and gas suction. Taking into consideration a breakage of magnetic bearings, touch down bearings ⑦ and ⑧ coated with solid lubrication have been installed. They do not contact with the rotor during the rated operation.

A radial sensor, an axial sensor, a rotation sensor and a temperature sensor always monitor the magnetic bearing as well as the rotor. If an abnormality/error occurs, the rotor will stop.

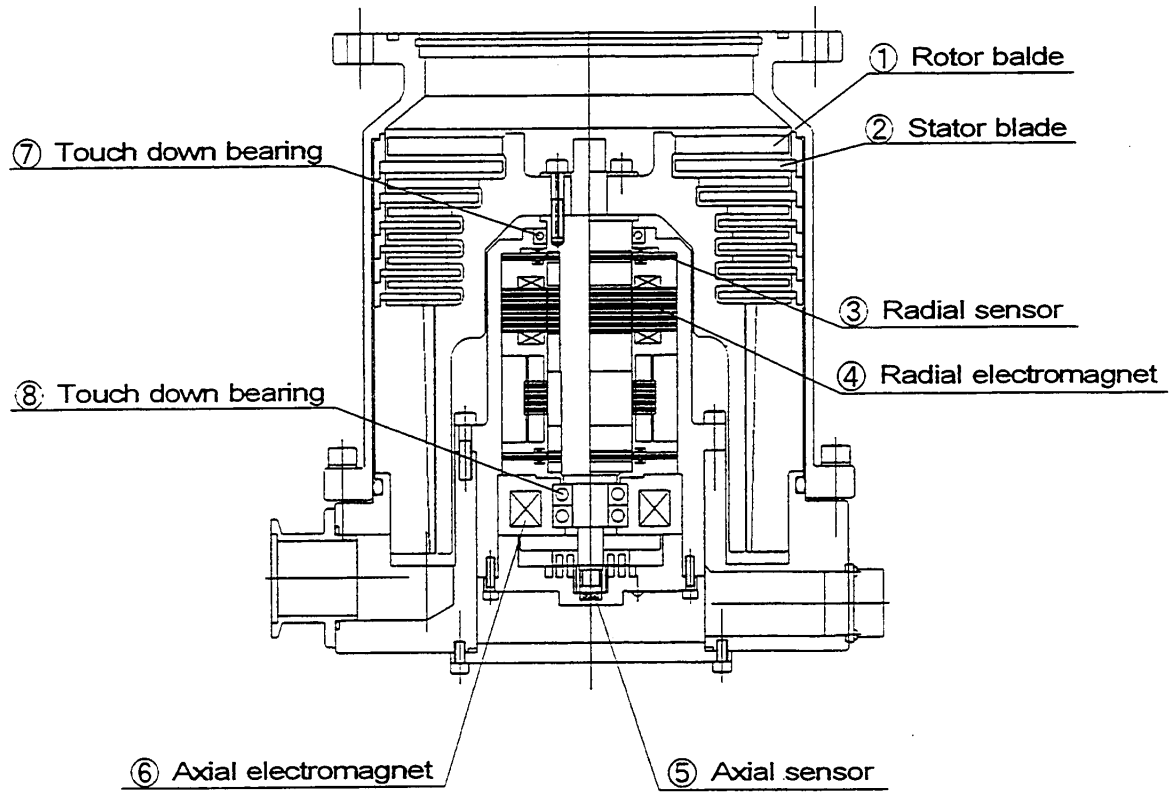

Figure 10.1 Cross Sectional View of the STP Pump

Section 11 Maintenance and Inspection



- ◇ Stop the STP pump, and turn OFF the primary power (Switch the breaker "OFF"), before performing inspections of the STP pump (for deposit).
Failure to do so may result in the inadvertent rotation of the STP pump, which may result in an accident.
- ◇ NEVER open any panel.
- ◇ Power OFF the baking heater and other peripheral equipment before performing maintenance and inspections.

11.1 Inspecting the Air Cooling Fan

Turn ON the primary power (Switch the breaker "ON").

Confirm that the air cooling fan (See Figure 4.4) at the STP control unit side panel (left) is operating.

If the air cooling fan is not operating, contact Service office to replace it.

It is recommended to inspect the air cooling fan once a year.

11.2 Inspecting for Deposit

- ◇ When inspecting for deposit, exhaust gases inside the STP pump thoroughly. Residual gases may cause an accident when removing the STP pump. Confirm the characteristics of gas to be used, referring to the Material Safety Data Sheet (MSDS) you obtain from the gas supplier. Wear personal protective equipment if necessary.

Leaving the STP pump without removing the deposit may cause the STP pump to be corroded beyond repair.

Deposit may have accumulated inside the STP pump depending upon the type of the vacuum equipment installed in the STP pump. An increase in the amount of deposit may lead to a malfunction of the STP pump.

Therefore, perform regular maintenance (once every three to six months as a target).

Inspect the inside of the outlet port flange for adhesion of deposit while watching the outlet port flange. If deposit has accumulated to some extent, an overhaul (cleaning) is required. Contact Service office.

Note that the costs of troubleshooting problems resulting from deposit will be at your own charge even during the warranty period.

If a problem resulting from deposit occurs inside the STP pump, hermetically seal inlet port, outlet port, purge port, and leak port flanges, and immediately return them to Service office. For the transport method, see Section 11.4, "Transport for Repair or Overhaul."



- ◇ Contact with atmospheric air may cause a reaction of the deposit. DO NOT open the STP pump to atmospheric air as much as possible.
- ◇ BOCET supplies you the Temperature Management System (TMS) unit to keep the temperature high inside the STP pump and prevent the accumulation of deposit. For details, contact Service office.

11.3 Overhaul

The recommended maintenance intervals for different process applications are tabulated below:

	Process	Period	Remarks
Etching*1	Metal Etch	1 year	Ensure that TMS (Temperature Management System) is fitted and operational to prevent accumulation of by-product deposition in the pump.
	Other Etch Processes	2 years	
	It is recommended to change the pump rotor after 5 years due to accumulated wear of the protective plating material		
	Other semiconductor process	2 years	Processes resulting in accumulation of deposits in the pump will require more frequent service.
	Clean applications (Only vacuum pumping)	5 years	
	Other use	(2 years)	Dependent on application, contact BOCET.



- ◇ The touch down bearing inside the STP pump will be worn out after a number of full speed touch downs. When the STP control unit displays “w,” it is essential to have the touch down bearings replaced.

The costs of replacing parts that need to be replaced because of deterioration or abrasion will be at your own charge.

When overhaul of the STP pump or the STP control unit is needed, contact Service office.

*1 “Etching” includes semiconductor etching and LCD etching.

11.4 Transporting for Repair or Overhaul

- ◇ When removing the STP pump from the vacuum equipment, exhaust gases inside the STP pump thoroughly.
Residual gases may result in an accident when removing the STP pump. Confirm the characteristics of gas to be used, referring to the Material Safety Data Sheet (MSDS) you obtain from the gas supplier.
- ◇ When returning the STP pump which has used corrosive, reactive or inflammable gases to Service office, specify the type of gas and handling precautions on the surface of the package.
Confirm the characteristics of gas to be used, referring to the Material Safety Data Sheet (MSDS) you obtain from the gas supplier.



- ◇ When returning the STP pump to Service office, be sure to pack it well to prevent external damage.
If any of the specifications has not been satisfied, BOCET will not be responsible for any damage during transport.

i) Always contact Service office before returning the STP pump for repairs, overhaul, or other purposes. To avoid any accident by gases or corrosion inside the STP pump, particularly when corrosive, reactive or flammable gases have been used, ii) vacuum and hermetically seal the STP pump before transport. iii) Specify the type of gases used and handling precautions on the package and return the STP pump to Service office.

When returning the STP pump to Service office, be sure to pack it well to prevent external damage. Use similar or superior packaging material as originally supplied by BOCET.



- ◇ The costs of cleaning and overhaul of the STP pump will be at your own charge.
- ◇ When returning the STP pump to Service office, fill in the necessary items in the "STP PUMP PROBLEM CHECK SHEET" and fax it to Service office.

Section 12 Storage

12.1 The STP Pump

When the STP pump is left unused over a long period (more than a few months), follow the precautions below:

- 1) Close the inlet port of the STP pump and vacuum it using an auxiliary pump.
- 2) Introduce dry N₂ gas or dry air from the outlet port or the purge port.
- 3) Close the outlet port and purge port.
- 4) If the STP pump is water cooled, introduce compressed air from one side of the cooling water port so that no water remains in the STP pump.
- 5) Store the STP pump in a vertical position.
- 6) DO NOT store the STP pump in the following places:
 - Place of high humidity.
(If it must be stored in a place of high humidity, insulate it from the outside and use a dehumidifying agent.)
 - Place of high temperatures (more than + 55 °C) and low temperatures (less than - 25 °C).
 - Place where there are corrosive gases.
 - Place subjected to dripping water.
 - Place with a lot of dust.
 - Place with insufficient ventilation.
 - Place subjected to strong magnetic or electric fields.
 - Place subjected to radiation.

12.2 The STP Control Unit

If the STP control unit (including cables) is not used for a long period (more than a few months), follow the precautions below:

- 1) Store the STP control unit in a horizontal position.
- 2) DO NOT store the STP control unit in the following places:
 - Place of high humidity.
(If it must be stored in a place of high humidity, insulate it from the outside and use a dehumidifying agent.)
 - Place of high temperature (more than + 55 °C) and low temperature (less than - 25 °C) (excluding the battery).
 - Place subjected to direct sunlight.
 - Place where there are corrosive gases.
 - Place subjected to dripping water.
 - Place with a lot of dust.
 - Place of insufficient ventilation.
 - Place subjected to strong magnetic or electric field.
 - Place subjected to radiation.
 - Place subjected to mist.
 - Place with electric noise.
 - Place with vibration.

Section 13 Disposal

13.1 The STP Pump

Dispose of the STP pump as **industrial waste** according to the guidelines given by each national and/or local government.



- ◇ When disposing of the STP pump, exhaust gases inside the STP pump thoroughly.
Residual gases may result in an accident when disposing of the STP pump.
If the STP pump has been used with reactive or corrosive gasses, always clean thoroughly before disposing of it to avoid any injury.
Confirm the characteristics of gas to be used, referring to the Material Safety Data Sheet (MSDS) you obtain from the gas supplier.



- ◇ BOCET is not responsible for problems during or after disposal.

13.2 The STP Control Unit

Dispose of the STP control unit as **industrial waste** according to the guidelines given by each national and/or local government.



- ◇ BOCET is not responsible for problems during or after disposal.

Section 14 Troubleshooting

If an abnormality/error is found when using the STP pump, check it and take measures in accordance with the following procedures.

If you cannot trace it or if the STP pump does not function normally after the troubleshooting, fill in the necessary information in the "STP PUMP PROBLEM CHECK SHEET" and fax it to Service office.



- ◇ After confirming that the STP pump stops thoroughly, turn OFF the primary power (switch the breaker "OFF"), and check probable causes and remove them.

14.1 Troubleshooting Immediately after an Abnormality/Error Occurs

<MANUAL OPERATION>

- i. After confirming that the "BRAKE" lamp goes out and the STP pump stops, remove the probable cause of the abnormality.
When the LCD displays an error message, take the necessary action according to Section 14.2. "When Error Message is Displayed on LCD."
- ii. Press the "RESET" switch to turn off the "FAILURE" lamp (RESET operation)
- iii. Press the "START" switch to restart the STP pump. Check if the STP pump operates correctly.

<REMOTE OPERATION>

- i. After confirming the "BRAKE" lamp goes out and the STP pump stops, remove the probable cause of the abnormality.
When the LCD displays an error message, take the necessary action according to Section 14.2. "When Error Message is Displayed on LCD."
- ii. Perform the RESET operation according to Section 5.6.5. "Starting the ST Pump after a Safety Function Operate " to turn off the "FAILURE" lamp
- iii. Restart the STP pump according to Section 5.6.2. "Starting/Stopping the STP Pump." Check if the STP pump operates correctly.



- ◇ When disconnecting cables from the STP pump and/or the STP control unit to perform troubleshooting and take the necessary action, confirm that the STP pump stops, turn OFF the primary power (Switch the breaker "OFF"), then disconnect the cables.
- ◇ If the RESET operation does not turn off the "FAILURE" lamp, confirm that the STP pump stops, turn OFF the primary power (Switch the breaker "OFF"), then turn ON the primary power again (Switch the breaker "ON").

14.2 When Error Message is Displayed on LCD

14.2.1 Error Messages

When an abnormality occurs, the "FAILURE" lamp lights and the LCD displays an error message.

If an ampersand "&" is shown at the right of the error message, it indicates that one or more errors occur. In this case, press the "SELECT" switch to display another error message

(The "SELECT" switch can also be used during remote operation).

Example)

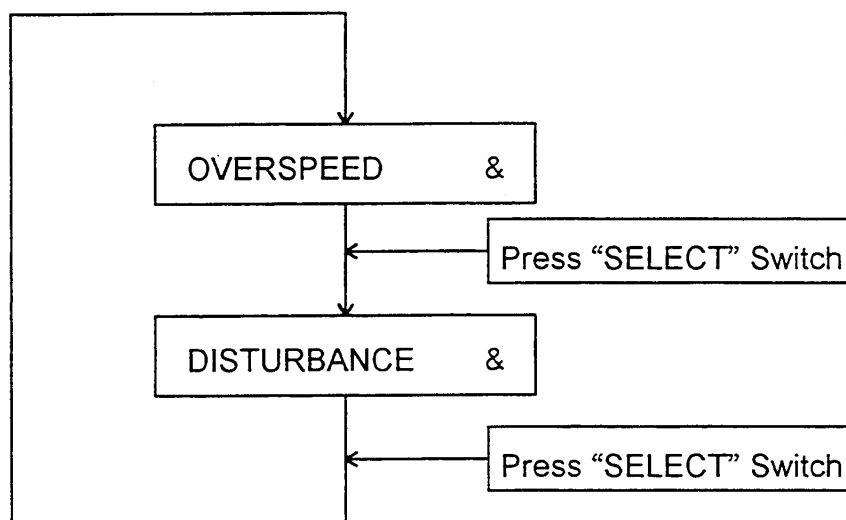

Table 14.1 Error Messages (1/3)

LCD Message	Probable Cause	Countermeasures	Referred Section
CABLE DISCONNECT	① Incorrect connection of the STP connection cable	Connect the cable correctly. If the cable connector is not locked, lock it securely.	4.4.2
	② Failure of the STP connection cable	Contact Service office.	Problem Check Sheet
CONTROLLER OT	① Overheating inside the STP control unit 1) Ambient temperature	1) Set the ambient temperature to 40°C or less.	4.2.1
	2) Insufficient cooling of the STP control unit	2) Remove obstacles at the ventilation port. If the air cooling fan is broken, contact Service office.	4.2.2 11.1
DISTURBANCE	① Abnormal magnetic bearing 1) The STP pump and the STP control unit have different serial numbers. 2) The cable length is changed.	1) Use the units having the same serial number, or perform tuning. 2) Perform tuning.	5 9.1 9.1
	② Excessive external vibration (vibration of 100 μ m0-P or more) 1) External vibration/impact 2) Atmospheric air flows into the STP pump 3) Foreign materials fall into the STP pump.	1) Remove external vibration so as not to transmit it to the STP pump. 2) Check the piping. 3) Install the STP pump in a way that no foreign materials fall into the STP pump.	3.3.4 3.3.4 3.3.1
DRIVER ERROR1 to DRIVER ERROR6	① Motor driver failure	Contact Service office.	Problem Check Sheet
L.V. DISCONNECT	① Incorrect connection of E.V. valve cable	Connect the cable correctly. If the cable connector is not locked, lock it securely.	4.4.2
	② Failure of E.V. valve cable	Contact Service office.	Problem Check Sheet
	③ Although E.V. valve is not used, dip switch 6 of DIP-B is set to ON.	Set dip switch 6 of DIP-B to OFF.	4.1.3

Table 14.1 Error Messages (2/3)

LCD Message	Probable Cause	Countermeasures	Referred Section
MOTOR HF	① Abnormal motor sensor	Contact Service office.	Problem Check Sheet
MOTOR OC	① Motor driver overcurrent	Contact Service office.	Problem Check Sheet
MOTOR OV	① Motor driver overvoltage	Contact Service office.	Problem Check Sheet
MOTOR RA	① STP pump overspeed (detected in the range of 35,000 rpm)	Contact Service office.	Problem Check Sheet
MOTOR UV	① Motor driver under voltage	Contact Service office.	Problem Check Sheet
OVERLOAD	① Motor driver overload 1) Insufficient pressure at the inlet port 2) Insufficient pressure at the outlet port 3) Leakage of the piping system 4) Failure of the auxiliary pump	1) Use at 13.3Pa (0.1 Torr)or less. 2) Use at 270 Pa (0.2 Torr) or less. 3) Check the piping system. 4) Check the capacity and start condition (use a pump of 240 lit./min. or more).	3.3.4 15.1 3.3.4 15.1 3.3.4 3.3 15.1
	② When the rated operation does not start approx. 15 min. after start operation is executed: ACCELERATION state continues for approx. 15 min.: 1) Incorrect connection of the motor connection cable 2) Failure of the motor connection cable	1) Connect the cable correctly. If the cable connector is not locked, lock it securely. 2) Contact Service office.	4.4.2 Problem Check Sheet
OVERSPEED	① STP pump overspeed (detected in the range of 35,000 rpm)	Contact Service office.	Problem Check Sheet

Table 14.1 Error Messages (3/3)

LCD Message	Probable Cause	Countermeasures	Referred Section
POWER FAILURE	① Power supply failure 1) Power failure 2) Incorrect connection of the power cable 3) Breakage of the power cable 4) Abnormal power voltage	1) Check whether or not a power failure has occurred. 2) Connect the power cable securely. 3) Replace the power cable. 4) Set the voltage to 200 to 240 V \pm 10% .	6.1.1 4.4.2 4.4.2 4.4.2
PUMP OVERTEMP	① Overheating inside the STP pump 1) Overheating during baking 2) Insufficient cooling 3) Leakage of the vacuum piping system 4) Repetitious start/stop operations	1) Set the temperature of baking heater to 120 °C or less. 2) At the time of baking or gas suction, always cool the STP pump. 3) Check the piping system for leakage. 4) Repetitious start/stop operations may cause the overheat.	7.3 7.2 3.3.4 5.2
RAM ERROR	① Failure of the microcomputer sequence circuit	Contact Service office.	Problem Check Sheet
TEST ERROR	① Abnormal end of self test	Contact Service office.	Problem Check Sheet
THERMAL ERROR	① Incorrect connection of the STP connection cable	Connect the cable correctly. If the cable connector is not locked, lock it securely.	4.4.2
	② Failure of the STP connection cable	Contact Service office.	Problem Check Sheet
	③ Breaking of the thermal sensor wire inside the STP pump	Contact Service office.	Problem Check Sheet
TMS ARARM (When the TMS unit is used)	① Abnormal TMS unit's temperature	Check the TMS unit's operation.	Instruction Manual of TMS unit
TMS BRAKER OFF (When the TMS unit is used)	① TMS control unit breaker OFF	Check the TMS control unit breaker.	Instruction Manual of TMS unit
TUNING ERROR1 to TUNING ERROR5	① Tuning error	Contact Service office.	Problem Check Sheet

14.3 Abnormalities When Powering ON

(When the "FAILURE" lamp lights and the LCD displays an error message, see Section 14.2. "When Error Message is Displayed on LCD.")

Table 14.2 Troubleshooting after Powering ON

No.	Symptom	Probable cause	Countermeasures	Referred Section
1	The "POWER" lamp does not light when powering ON.	① Incorrect connection of power cable	Connect the power cable correctly.	4.4.2
		② Abnormal power voltage	Set the voltage to 200 to 240 V \pm 10%.	4.4.2 15.2
		③ Power failure	Check whether or not a power failure has occurred.	6.1.1

14.4 Abnormalities When Performing the STP Pump Start Operation

(When the "FAILURE" lamp lights and the LCD displays an error message, see Section 14.2. "When Error Message is Displayed on LCD.")

Table 14.3 Troubleshooting When Performing the STP Pump Start Operation

No.	Symptom	Probable cause	Countermeasures	Referred Section
1	The "ACCEL." lamp does not light.	① LCD message (MANUAL operation only)	Press the "SELECT" switch one or more times until the LCD displays "LEVITATION" or "BRAKE ***00rpm."	4.1.1 5.5
		② The "MANUAL/REMOTE" changeover switch is not at the correct position.	Slide the "MANUAL/REMOTE" changeover switch to the correct position.	4.1.1 5.5 5.6
		③ ROTATION INHIBIT signal input pins (CON4 INHIBIT ①-⑤ are opened.)	When not using this function, short the circuits between ①-⑤, or set dip switch 7 of DIP-B to ON. If these pins are opened, the STP pump will not rotate after performing start operation.	8.1 4.1.3
2	The rotation speed does not increase (from 0 rpm).	① Incorrect connection of motor connection cable	Connect the cable correctly. If the cable connector is not locked, lock it securely.	4.4.2

14.5 Other Abnormalities

(When the "FAILURE" lamp lights and the LCD displays an error message, see Section 14.2, "When Error Message is Displayed on LCD.")

Table 14.4 Troubleshooting While the STP Pump Is Rotating

No.	Symptom	Probable causes	Countermeasures	Referred Section
1	Insufficient ultimate pressure	Failure of the auxiliary pump	Check the auxiliary pump for its capacity and START state (use a pump with the recommended capacity or more).	3.3 15.1
		Leakage of the piping system	Check the piping system for leakage.	3.3.4
		Residual molecules	If the main composition is H ₂ or H ₂ O, perform baking; if it is other gases, clean the inside of the vacuum equipment (If gases remain inside the STP pump, contact Service office when it is needed to be cleaned).	7.3 11.4
2	The STP pump stops.	ROTATION INHIBIT signal input pins (CON4 INHIBIT (1)-(5) are opened.)	When not using this function, short the circuit between (1)-(5), or set dip switch 7 of DIP-B to ON. If these pins are opened, the STP pump will not rotate after performing start operation.	8.1 4.1.3
3	Tuning cannot be performed.	Dip switch 8 of DIP-B is set to OFF.	Set dip switch 8 of DIP-B to ON.	4.1.3
4	E. V. valve does not function.	Dip switch 6 of DIP-B is set to OFF.	Set dip switch 6 of DIP-B to ON.	4.1.3
5	ROTATION INHIBIT signal does not function correctly.	Dip switch 7 of DIP-B is set to ON.	Set dip switch 7 of DIP-B to OFF.	4.1.3 8.1

UNIT CONVERSION TABLE

Length

m	cm	mm	inch
1	100	1.00×10^3	39.4
0.01	1	10.0	0.394
1×10^{-3}	0.10	1	39.4×10^{-3}
25.4×10^{-3}	2.54	25.4	1

Weight

g	kg	lb.
1	1.00×10^{-3}	2.20×10^{-5}
1×10^{-3}	1	2.20
454	0.454	1

Pressure

Pa	Torr	kgf/cm ²
1	7.50×10^{-3}	1.02×10^{-5}
133	1	1.36×10^{-3}
9.81×10^4	736	1

For more information, contact to the nearest Service Office.

Manufacture:

BOC Edwards Technologies Limited

4-3-1, Yashiki, Narashino-shi, Chiba, 275-0004 JAPAN

Telephone:	Domestic	047-475-6161
	International	+81-47-475-6161
Facsimile:	Domestic	047-478-6537
	International	+81-47-478-6537

**STP-H1301L1 Series
Turbomolecular Pump
INSTRUCTION MANUAL (EXCERPT)
(Second Edition -a)**

**This Manual picks up the points of difference between the STP-H1301 Series and the STP-H1301L1. For the “Safety Precautions,” installation, operation and maintenance, read the “STP-H1301 Series Instruction Manual.”
Keep this Manual in a place where you can quickly access it at any time.**

INTRODUCTION

Thank you very much for purchasing BOC Edwards Technologies' turbomolecular pump.

The turbomolecular pump is designed to be installed in the vacuum equipment to exhaust gases from it.

This manual covers all items necessary to ensure safe installation, operation and maintenance of the following series of the STP-H1301L1 turbomolecular pump:

- | Model Name | Specification |
|---------------|--|
| • STP-H1301L1 | High-throughput type, Enhanced chemical specific*1 |

For the specifications of other models of the STP-H1301L1 pump series, contact BOCET.

In this manual, the above STP pump series is collectively referred to as the "STP pump."

This Manual picks up the points of difference between the STP-H1301 Series and the STP-H1301L1. For the "Safety Precautions," installation, operation and maintenance, read the "STP-H1301 Series Instruction Manual."

The points of difference are as follows:

- Pump Specification

*1 : Enhanced chemical specific: STP pump for which anti-corrosive treatment is improved for the inside of the pump of the chemical specific type

Chemical specific: STP pump with anti-corrosive treatment (responding to chlorine, fluorine or other system gases)

TABLE OF CONTENTS

1 Specifications and Accessories	1-1
1.1 Specifications for the STP Pump	1-1
1.2 The measurement condition of “Maximum N ₂ flow rate” and “Maximum working pressure”	1-2
1.3 Accessories	1-4

TABLES

Table 1.1 Specifications for the STP-H1301L1	1-1
Table 1.2 The measurement condition of “Maximum N ₂ flow rate” and “Maximum working pressure”	1-2
Table 1.3 Accessories	1-4

FIGURES

Figure 1.1 The measurement equipment of “Maximum N ₂ flow rate” and “Maximum working pressure”	1-3
--	-----

1 Specifications and Accessories

1.1 Specifications for the STP Pump

Table 1.1 Specifications for the STP-H1301L1

Item		Specifications
Flange type	Inlet Port	ISO200F
	Outlet Port	KF40
Pumping speed	N ₂	1300 lit./sec.
	He	1200 lit./sec.
	H ₂	1000 lit./sec.
Compression ratio	N ₂	>10 ⁸
	He	2x10 ⁵
	H ₂	8x10 ³
Ultimate pressure (after baking out)		10 ⁻⁶ Pa order (10 ⁻⁸ Torr order)
Maximum N ₂ flow rate* ¹		450 SCCM
Maximum working pressure* ¹	Pa (Torr)	1 (0.008)
Allowable backing pressure	Pa (Torr)	266 (2)
Rated speed		32,500 rpm
Starting time		7min.
Stopping time		8min.
Baking temperature		<120°C
Lubricating oil		Not necessary
Installation position		Vertical/Upside down
Weight		36kg

Specification by the conditions that kept temperature of base of STP pump at 50°C.

Pumping speed, Compression ratio, Ultimate pressure, Maximum working pressure and Allowable backing pressure are measured by BOCET method.

*¹: The measurement condition of "Maximum N₂ flow rate" and "Maximum working pressure" are shown in "1.2 The measurement condition of "Maximum N2 flow rate".

1.2 The measurement condition of “Maximum N₂ flow rate” and “Maximum working pressure”

“Maximum N₂ flow rate” and “Maximum working pressure” are measured below conditions. And this is the measured value when the N₂ gas is exhausted.
(Measurement equipment : See Figure 1.1)

Table 1.2 The measurement condition of “Maximum N₂ flow rate” and “Maximum working pressure”

Item	Condition
Gas	N ₂ gas is exhausted.
Chamber	With heater; heater control temperature is 60°C. Valve throttle is controlled chamber pressure to 12Pa(0.09Torr).
Gate valve	<ul style="list-style-type: none"> • VAT64 series (with heater, heater control temperature is 60°C) • VAT65series (with heater, heater control temperature is 70°C) Use VAT64 series or VAT65series.
STP pump	Base of STP pump control temperature is 50°C. Measuring point of temperature: Hole for sensor on base of STP pump. Control method: Base heater is continuously ON. Cooling water in ON/OFF controlled.
Back pump	Dry pump: Maximum pumping speed is 1,300lit./min. or over.

NOTICE

- ◇ When these are used with other conditions, maximum flow rate is changed. In this case, contact Service office.
- ◇ At a different position of pump inlet port, pressure is different by conductance between pump inlet port and the pressure measurement positions.
If operating pressure condition is set at a different position of pump inlet port, set up the flow rate which a pump exhausts within maximum flow rate.

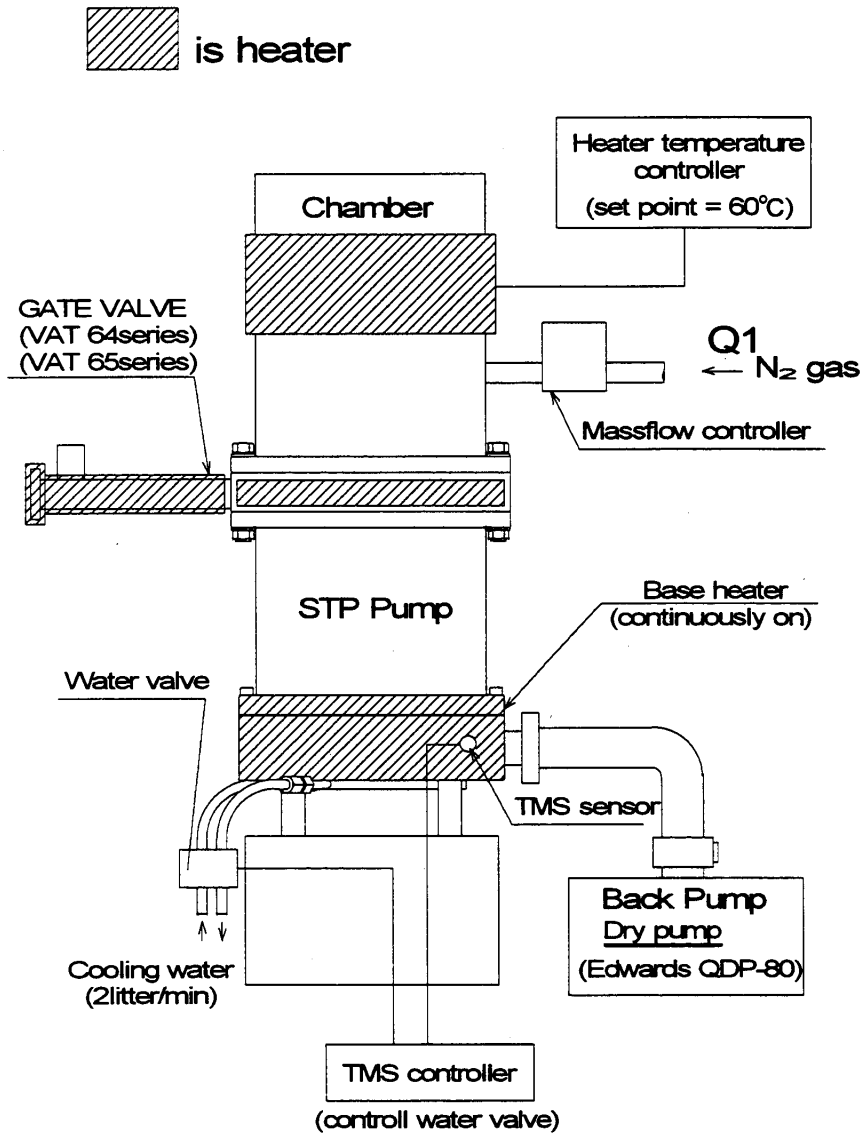

Figure 1.1 The measurement equipment of “Maximum N₂ flow rate” and “Maximum working pressure”

1.3 Accessories

Table 1.3 Accessories

Item	Q'ty	Remakes
STP control unit	1	
Power cable (5m)	1	With a single-side connector, and other side crimp-type terminal lug.
STP connection cable (0.9m)	1	with both-side connectors (pump side: angle connector)
Motor connection cable(1m)	1	with both-side connectors (pump side: angle connector)
Ground cable(1m)	1	with both-side crimp-type terminal lugs
Inlet port cover	1	
Outlet port cover	1	
STP connector cover	1	
Motor connector cover	1	
Blank flange for purge port	1	KF10*1
Clamping ring for purge port	1	KF10(with O-ring washer)
Leg	8	4 legs are attached to the STP pump
Rubber foot for leg	4	
Instruction Manual	1	

*1 : JIS

For more information, contact to the nearest Service Office.

Manufacture:

BOC Edwards Technologies Limited

4-3-1, Yashiki, Narashino-shi, Chiba, 275-0004 JAPAN

Telephone: Domestic 047-475-6161

International +81-47-475-6161

Facsimile: Domestic 047-478-6537

International +81-47-478-6537

**STP-H1301L1B Series
Turbomolecular Pump
INSTRUCTION MANUAL (excerpt)
(First Edition)**

This Manual picks up the points of difference between the STP-H1301 Series and the STP-H1301L1B. For the “Safety Precautions,” installation, operation and maintenance, read the “STP-H1301 Series Instruction Manual.” Keep this Manual in a place where you can quickly access it at any time.

INTRODUCTION

Thank you very much for purchasing BOC Edwards Technologies' turbomolecular pump.

The turbomolecular pump is designed to be installed in the vacuum equipment to exhaust gases from it.

This manual covers all items necessary to ensure safe installation, operation and maintenance of the following series of the STP-H1301L1B turbomolecular pump:

- | Model Name | Specification |
|----------------|--|
| • STP-H1301L1B | High-throughput type, Enhanced chemical specific*1 |

For the specifications of other models of the STP-H1301L1B pump series, contact BOCET.

In this manual, the above STP pump series is collectively referred to as the "STP pump."

This Manual picks up the points of difference between the STP-H1301 Series and the STP-H1301L1B. For the "Safety Precautions," installation, operation and maintenance, read the "STP-H1301 Series Instruction Manual."

The points of difference are as follows:

- Pump Specification

*1 : Enhanced chemical specific: STP pump for which anti-corrosive treatment is improved for the inside of the pump of the chemical specific type

Chemical specific: STP pump with anti-corrosive treatment (responding to chlorine, fluorine or other system gases)

TABLE OF CONTENTS

1 Specifications and Accessories	1-1
1.1 Specifications for the STP Pump	1-1
1.2 The measurement condition of “Maximum N ₂ flow rate” and “Maximum working pressure”	1-2
1.3 Accessories	1-4

TABLES

Table 1.1 Specifications for the STP-H1301L1B	1-1
Table 1.2 The measurement condition of “Maximum N ₂ flow rate” and “Maximum working pressure”	1-2
Table 1.3 Accessories	1-4

FIGURES

Figure 1.1 The measurement equipment of “Maximum N ₂ flow rate” and “Maximum working pressure”	1-3
--	-----

1 Specifications and Accessories

1.1 Specifications for the STP Pump

Table 1.1 Specifications for the STP-H1301L1B

Item		Specifications
Flange type	Inlet Port	ISO200F
	Outlet Port	KF40
Pumping speed	N ₂	1300 lit./sec.
	He	1200 lit./sec.
	H ₂	1000 lit./sec.
Compression ratio	N ₂	>10 ⁸
	He	2x10 ⁵
	H ₂	8x10 ³
Ultimate pressure (after baking out)		10 ⁻⁶ Pa order (10 ⁻⁸ Torr order)
Maximum N ₂ flow rate* ¹		600 SCCM
Maximum working pressure* ¹ Pa (Torr)		2 (0.016)
Allowable backing pressure Pa (Torr)		266 (2)
Rated speed		32,500 rpm
Starting time		7min.
Stopping time		8min.
Baking temperature		<120°C
Lubricating oil		Not necessary
Installation position		Vertical/Upside down
Weight		36kg

Specification by the conditions that kept temperature of base of STP pump at 60°C.

Pumping speed, Compression ratio, Ultimate pressure, Maximum working pressure and Allowable backing pressure are measured by BO CET method.

*¹: The measurement condition of "Maximum N₂ flow rate" and "Maximum working pressure" are shown in "1.2 The measurement condition of "Maximum N₂ flow rate".

1.2 The measurement condition of “Maximum N₂ flow rate” and “Maximum working pressure”

“Maximum N₂ flow rate” and “Maximum working pressure” are measured below conditions. And this is the measured value when the N₂ gas is exhausted.
(Measurement equipment : See Figure 1.1)

Table 1.2 The measurement condition of “Maximum N₂ flow rate” and “Maximum working pressure”

Item	Condition
Gas	N ₂ gas is exhausted.
Chamber	With heater; heater control temperature is 60°C. Valve throttle is controlled chamber pressure to 12Pa(0.09Torr).
Gate valve	<ul style="list-style-type: none"> • VAT64 series (with heater, heater control temperature is 60°C) • VAT65series (with heater, heater control temperature is 70°C) Use VAT64 series or VAT65series.
STP pump	Base of STP pump control temperature is 60°C. Measuring point of temperature: Hole for sensor on base of STP pump. Control method: Base heater is continuously ON. Cooling water in ON/OFF controlled.
Back pump	Dry pump: Maximum pumping speed is 1,300lit./min. or over.

NOTICE

- ◇ When these are used with other conditions, maximum flow rate is changed. In this case, contact Service office.
- ◇ At a different position of pump inlet port, pressure is different by conductance between pump inlet port and the pressure measurement positions.
If operating pressure condition is set at a different position of pump inlet port, set up the flow rate which a pump exhausts within maximum flow rate.

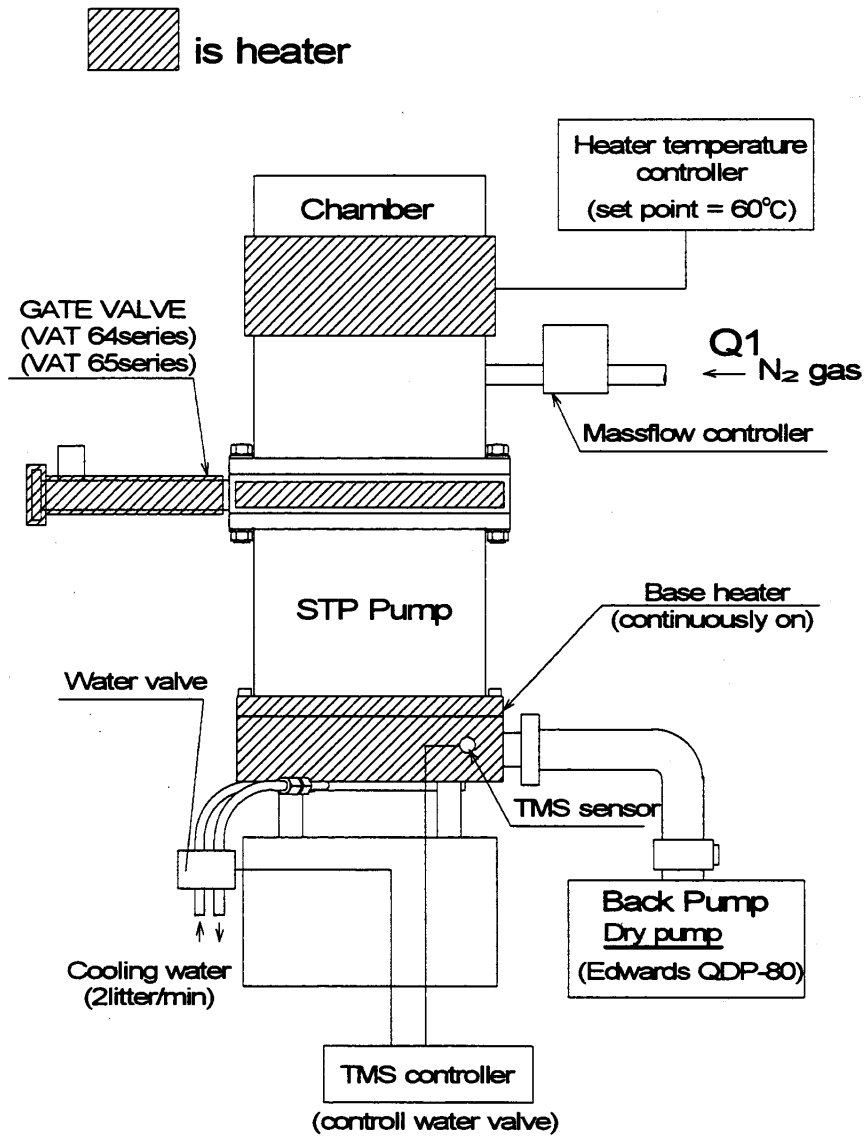

Figure 1.1 The measurement equipment of “Maximum N₂ flow rate” and “Maximum working pressure”

1.3 Accessories

Table 1.3 Accessories

Item	Q'ty	Remakes
STP control unit	1	
Power cable (5m)	1	With a single-side connector, and other side crimp-type terminal lug.
STP connection cable (0.9m)	1	with both-side connectors (pump side: angle connector)
Motor connection cable(1m)	1	with both-side connectors (pump side: angle connector)
Ground cable(1m)	1	with both-side crimp-type terminal lugs
Inlet port cover	1	
Outlet port cover	1	
STP connector cover	1	
Motor connector cover	1	
Blank flange for purge port	1	KF10*1
Clamping ring for purge port	1	KF10(with O-ring washer)
Leg	8	4 legs are attached to the STP pump
Rubber foot for leg	4	
Instruction Manual	1	

*1 : JIS

For more information, contact to the nearest Service Office.

Manufacture:

BOC Edwards Technologies Limited

4-3-1, Yashiki, Narashino-shi, Chiba, 275-0004 JAPAN

Telephone: Domestic 047-475-6161
International +81-47-475-6161

Facsimile: Domestic 047-478-6537
International +81-47-478-6537

Return of BOC Edwards Equipment - Procedure

INTRODUCTION

Before returning your equipment, you must warn BOC Edwards if substances you used (and produced) in the equipment can be hazardous. This information is fundamental to the safety of our Service Centre employees and will determine the procedures employed to service your equipment.

Complete the Declaration (HS2) and send it to BOC Edwards before you dispatch the equipment. It is important to note that this declaration is for BOC Edwards internal use only, and has no relationship to local, national or international transportation safety or environmental requirements. As the person offering the equipment for shipment, it is your responsibility to ensure compliance with applicable laws.

GUIDELINES

- Equipment is '**uncontaminated**' if it has not been used, or if it has only been used with substances that are not hazardous. Your equipment is '**contaminated**' if it has been used with any substances classified as hazardous under EU Directive 67/548/EEC (as amended) or OSHA Occupational Safety (29 CFR 1910).
- If your equipment has been used with radioactive substances, biological or infectious agents, mercury, polychlorinated biphenyls (PCB's), dioxins or sodium azide, you must decontaminate it before you return it to BOC Edwards. You must send independent proof of decontamination (for example a certificate of analysis) to BOC Edwards with the Declaration (HS2). Phone BOC Edwards for advice.
- If your equipment is contaminated, you must either:
 - Remove all traces of contamination (to the satisfaction of laws governing the transportation of dangerous/hazardous substances).
 - Or, properly classify the hazard, mark, manifest and ship the equipment in accordance with applicable laws governing the shipment of hazardous materials.

Note: Some contaminated equipment may not be suitable for airfreight.

PROCEDURE

1. Contact BOC Edwards and obtain a Return Authorisation Number for your equipment.
2. Complete the Return of BOC Edwards Equipment - Declaration (HS2).
3. If the equipment is contaminated, you must contact your transporter to ensure that you properly classify the hazard, mark, manifest and ship the equipment, in accordance with applicable laws governing the shipment of contaminated/hazardous materials. As the person offering the equipment for shipment, it is your responsibility to ensure compliance with applicable law. **Note: Equipment contaminated with some hazardous materials, such as semiconductor by-products, may not be suitable for airfreight - contact your transporter for advice.**
4. Remove all traces of hazardous gases: pass an inert gas through the equipment and any accessories that will be returned to BOC Edwards. Where possible, drain all fluids and lubricants from the equipment and its accessories.
5. Seal up all of the equipment's inlets and outlets (including those where accessories were attached) with blanking flanges or, for uncontaminated product, with heavy gauge tape.
6. Seal equipment in a thick polythene/polyethylene bag or sheet.
7. If the equipment is large, strap the equipment and its accessories to a wooden pallet. If the equipment is too small to be strapped to a pallet, pack it in a suitable strong box.
8. Fax or post a copy of the Declaration (HS2) to BOC Edwards. The Declaration must arrive before the equipment.
9. Give a copy of the Declaration (HS2) to the transporter. You must tell your transporter if the equipment is contaminated.
10. Seal the original Declaration in a suitable envelope: attach the envelope securely to the outside of the equipment package, in a clear weatherproof bag.

WRITE YOUR RETURN AUTHORISATION NUMBER CLEARLY ON THE OUTSIDE OF THE ENVELOPE OR ON THE OUTSIDE OF THE EQUIPMENT PACKAGE.

Return of BOC Edwards Equipment - Declaration

Return Authorisation Number:

You must:

- Know about all of the substances which have been used and produced in the equipment before you complete this Declaration
- Read the Return of BOC Edwards Equipment - Procedure (HS1) before you complete this Declaration
- Contact BOC Edwards to obtain a Return Authorisation Number and to obtain advice if you have any questions
- Send this form to BOC Edwards before you return your equipment

SECTION 1: EQUIPMENT

Equipment/System Name _____

Part Number _____

Serial Number _____

Has the equipment been used, tested or operated ?

 YES Go to Section 2 NO Go to Section 4

IF APPLICABLE:

Tool Reference Number _____

Process _____

Failure Date _____

Serial Number of Replacement Equipment _____

SECTION 2: SUBSTANCES IN CONTACT WITH THE EQUIPMENT
Are any substances used or produced in the equipment:

- Radioactive, biological or infectious agents, mercury, poly chlorinated biphenyls (PCBs), dioxins or sodium azide? (if YES, see Note 1) YES NO
- Hazardous to human health and safety? YES NO

Note 1 : BOC Edwards will not accept delivery of any equipment that is contaminated with radioactive substances, biological/infectious agents, mercury, PCB's, dioxins or sodium azide, unless you:

- Decontaminate the equipment
- Provide proof of decontamination

YOU MUST CONTACT BOC EDWARDS FOR ADVICE BEFORE YOU RETURN SUCH EQUIPMENT

SECTION 3: LIST OF SUBSTANCES IN CONTACT WITH THE EQUIPMENT

Substance name	Chemical Symbol	Precautions required (for example, use protective gloves, etc.)	Action required after a spill, leak or exposure

SECTION 4: RETURN INFORMATION

Reason for return and symptoms of malfunction _____

- If you have a warranty claim:
- who did you buy the equipment from ? _____
 - give the supplier's invoice number _____

SECTION 5: DECLARATION

Print your name: _____ Print your job title: _____

Print your organisation: _____

Print your address: _____

Telephone number: _____ Date of equipment delivery: _____

I have made reasonable enquiry and I have supplied accurate information in this Declaration. I have not withheld any information, and I have followed the Return of BOC Edwards Equipment - Procedure (HS1).

Note: Please print out this form, sign it and return the signed form as hard copy.

Signed: _____ Date _____

UNITED KINGDOM**CORPORATE HEADQUARTERS****BOC EDWARDS**

Manor Royal
Crawley
West Sussex
RH10 9LW
Tel +(44) 1293 528844
Fax +(44) 1293 533453

BOC EDWARDS

Wingates Industrial Estate
Great Bank Road
Westhoughton, Bolton
Lancashire
BL5 3SL
Tel +(44) 1942 652652
Fax +(44) 1942 652651

AMERICA (USA)**USA HEADQUARTERS****BOC EDWARDS**

One Edwards Park
301 Ballardvale Street
Wilmington, MA 01887
Tel +(1) 978 658 5410
Toll free (USA only) 1 800 848 9800
Fax +(1) 978 658 7969

3901 Burton Drive
Santa Clara, CA 95054
Tel +(1) 408 496 1177
Fax +(1) 408 496 1188

1810 West Drake Drive
Suite 101
Tempe, AZ 85283
Tel +(1) 602 777 7007
Fax +(1) 602 777 2244

11701 Stonehollow Drive
Suite 100
Austin, TX 78758
Tel +(1) 512 491 6622
Fax +(1) 512 491 0629

3501 Island Avenue
Philadelphia, PA 19153
Tel +(1) 215 365 8653
Fax +(1) 978 753 6846

BELGIUM**BOC EDWARDS**

Bergensesteenweg 709
B1600 Sint-Pieters-Leeuw
Brussels
Tel +(32) 2 363 0030
Fax +(32) 2 363 0064

BRAZIL**BOC DO BRASIL LTDA
DIVISÃO EDWARDS ALTO VACO**

Rua Bernardo Wrona 222
02710 São Paulo-SP
Tel +(55) 11 3952 5000
Fax +(55) 11 3965 2766

CANADA**BOC EDWARDS**

5975 Falbourne Street
Mississauga, Ontario L5R3W6
Canada
Tel +(1) 905 501 2558
Fax +(1) 905 501 1632

12055 Cote de Liesse
Dorval, Quebec H9P1B4
Canada
Tel +(1) 514 631 3501
Fax +(1) 514 631 3502

CHINA**BOC TRADING
(SHANGHAI) CO. LTD.**

23 Fu Te Road (N)
Wai Gao Qiao Free Trade Zone
Pudong
Shanghai, 200131
PRC China
Tel +(86 21) 5866 9618
Fax +(86 21) 5866 9993

FRANCE**BOC EDWARDS**

125 Avenue Louis Roche
92238 Gennevilliers, Cedex
Paris
Tel +(33) 1 47 98 24 01
Fax +(33) 1 47 98 44 54

GERMANY**BOC EDWARDS**

Ammerthalstraße 36
85551 Kirchheim
Munich
Tel +(49) 89 99 19 18 0
Fax +(49) 89 99 19 18 99

HONG KONG S.A.R.**BOC EDWARDS (ASIA)**

12 Chun Yat Street
Tseung Kwan O Industrial Estate
Tseung Kwan O, Kowloon
Hong Kong S.A.R.
Tel +(852) 2372 2640
Fax +(852) 2796 9095

INDIA**BOC EDWARDS**

DIVIN. OF BOC INDIA LIMITED
203 Surya Kiran Building
19 Kasturba Gandhi Marg
New Delhi - 110 001
India
Tel +(91) 11 851 0065
Fax +(91) 11 851 0245

ISRAEL**EDWARDS ISRAEL VACUUM LTD.**

5 Habarzel Blvd
Gat 2000 Industrial Zone
Qiryat Gat 82000
Tel +(972) 8 681 0633
Fax +(972) 8 681 0640

ITALY**BOC EDWARDS**

Via Carpaccio 35
20090 Trezzano sul Naviglio
Milan
Tel +(39) 02 48 4471
Fax +(39) 02 48 401638

JAPAN**HEADQUARTERS****BOC EDWARDS**

Shuwa Shiba Park Building A-3F
2-4-1 Shibakoen Minato-ku
Tokyo, 105-0011
Tel +(81) (0) 3 5470 6530
Fax +(81) (0) 3 5470 6521

KOREA**HEADQUARTERS****SONGWON EDWARDS LTD.**

5th FL. Daewoo Engineering Bldg.
Soonae-dong
Bundang-gu, Sungnam City
Kyungki-do, Korea
Tel +(82) 31 716 7070
Fax +(82) 31 738 1001-3

FACTORY & GV**SONGWON EDWARDS LTD.**

625-7 Upsong-dong
Chunan City
Chungchong Nam-do
Korea
Tel +(82) 41 621 7070
Fax +(82) 41 621 7700

SINGAPORE**BOC EDWARDS (ASIA)**

42 Loyang Drive
Loyang Industrial Estate
Singapore 508962
Tel +(65) 6546 8408
Fax +(65) 6546 8407

TAIWAN, R.O.C.**EDWARDS TECHNOLOGIES
LIMITED**

No. 434 Chung hua Road
Toufen Town, Miaoli County
Taiwan ROC
Tel +(886) 37 611422
Fax +(886) 37 611401

PLEASE CONTACT ANY OF THESE COMPANIES FOR DETAILS OF OTHER SALES AND SERVICE CENTRES IN YOUR AREA.

BOC Edwards is part of BOC Limited. BOC Edwards and the stripe symbol are trade marks of The BOC Group.

© BOC Edwards 2003

Produced by Technical Publicity Techpublicity@edwards.boc.com

<http://www.bocedwards.com>
info@bocedwards.com

 **BOC EDWARDS**